

233-32961_020

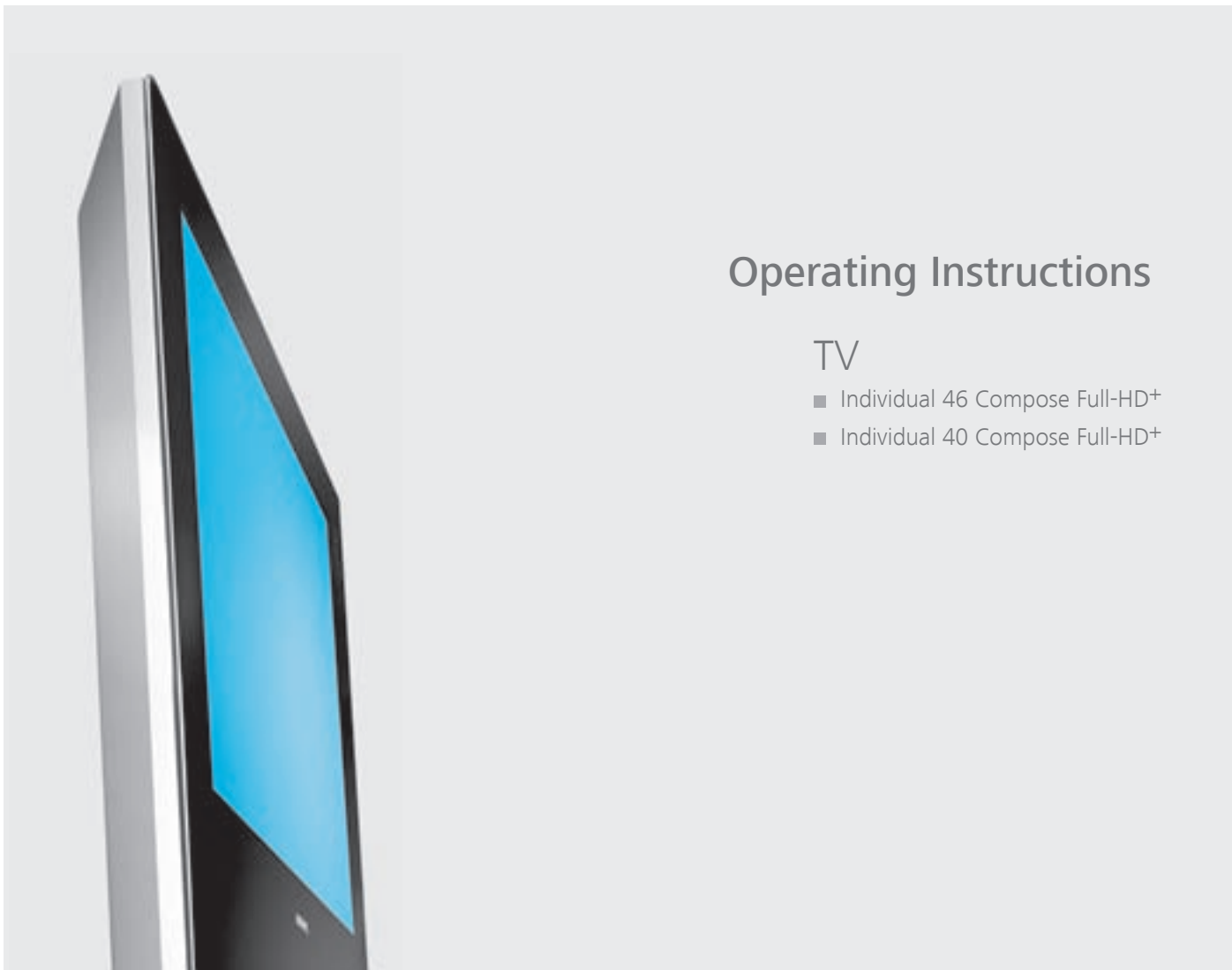

Operating Instructions

TV

- Individual 46 Compose Full-HD+
- Individual 40 Compose Full-HD+

LOEWE.

Contents

Remote Control – TV Functions	3
Control unit front side of the device	4
Connections rear side of the device	5
Welcome.....	6
Scope of delivery	6
About this operating manual	6
TV set equipment.....	6
Trademarks.....	6
Acknowledgements	6
Operating convenience with wizards	7
The wizards in overview	7
Info display and TV index.....	7
For your safety	8
Environmental protection	9
Initial installation.....	10
Installing the TV set	10
Removing the protective foil	10
Preparing the remote control unit	10
Connecting the TV set.....	10
Turning the set on/off	11
First installation wizard.....	11
Positioning/aligning DVB-T antenna	13
Operating convenience	13
General information on menu operation.....	13
The info display	14
The index in the TV set.....	14
TV menu – Overview diagram	15
Radio menu – Overview diagram	15
Daily operation	16
Select station.....	16
Select video source	17
Adjusting the sound	18
Adjusting the picture	19
Operation without remote control	19
Button functions.....	20
Managing stations	22
TV stations	22
Put together – change favourites lists	24
Picture in Picture.....	26
Picture in Picture (PIP)	26
Configure Picture in Picture (PIP) mode	27
Electronic Programme Guide	28
Electronic Programme Guide – EPG.....	28
Configuring EPG	29
Teletext.....	30
Teletext	30
Teletext menu.....	31
DVB.....	32
Conditional Access Module (CA module)	32
Software update	33
Radio	34
Radio mode	34
EPG – Electronic Programme Guide (radio).....	34
Operating additional equipment.....	35
Device connection wizard	35
Connecting devices to the HDMI (DVI) connections and playback	37
Connecting devices to the PC IN connection and playback.....	37
Connecting devices to the Component IN connection and playback.....	38
Sound components wizard.....	39
TV speakers	39
Speaker system Loewe Individual Sound on the Dolby Digital Decoder of the TV set.....	40
Connecting other speaker systems or active speakers to the Dolby Digital Decoder	41
Adjusting the speaker system.....	41
Connecting audio amplifiers	44
Assignment of the digital audio input	45
Audio connection in HDMI (DVI) devices	45
The direct way to record	46
Timer recording with external devices.....	47
PhotoViewer.....	48
Operating Loewe equipment.....	50
Rotating the TV set	51
Troubleshooting	52
Technical data	54
General data	54
Electrical data	54
Connections	54
Accessories.....	55
Accessories.....	55
Setup possibilities.....	55
Glossary.....	56
Index	59
Service.....	60

Remote Control – TV Functions

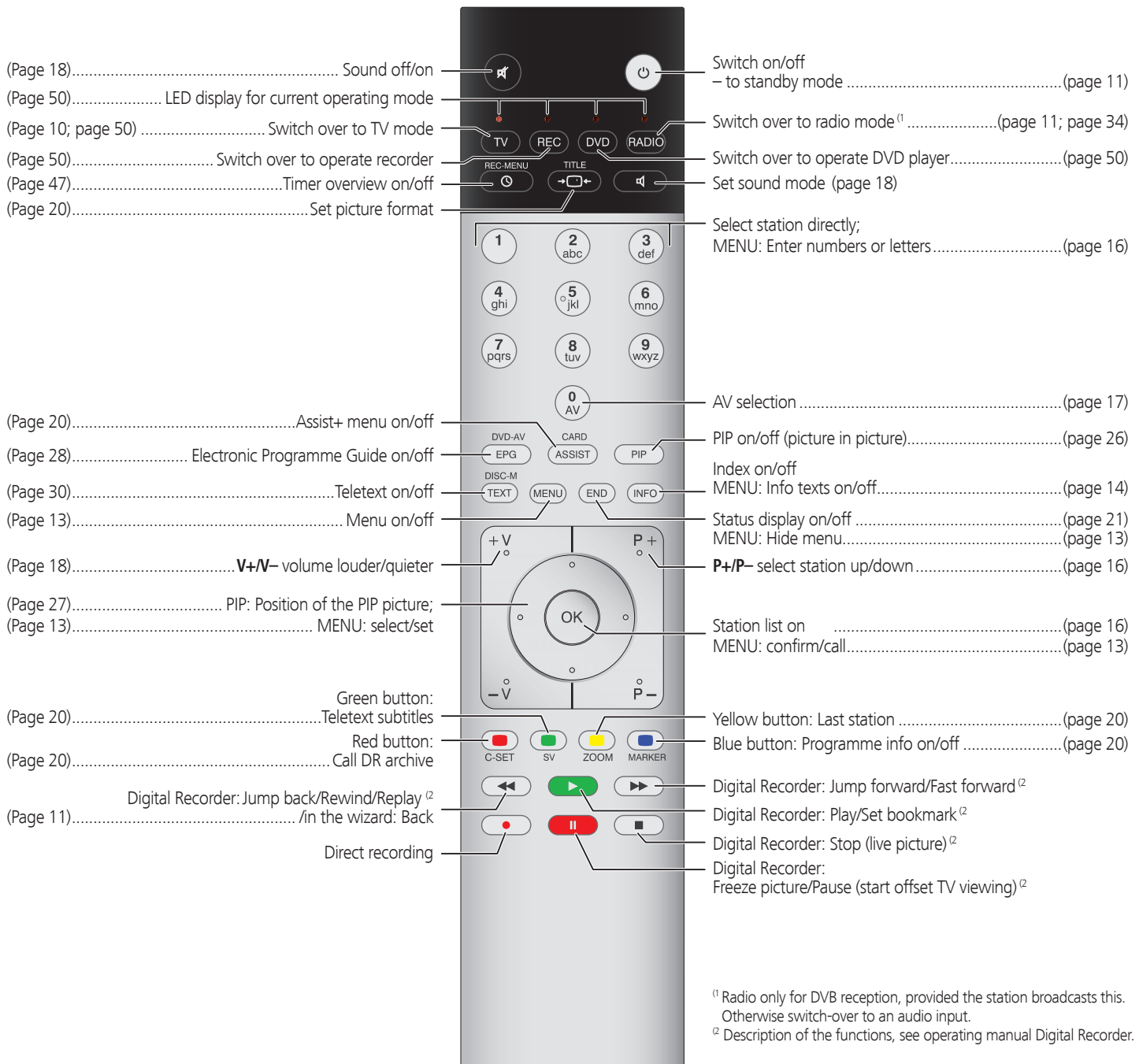

Control unit front side of the device

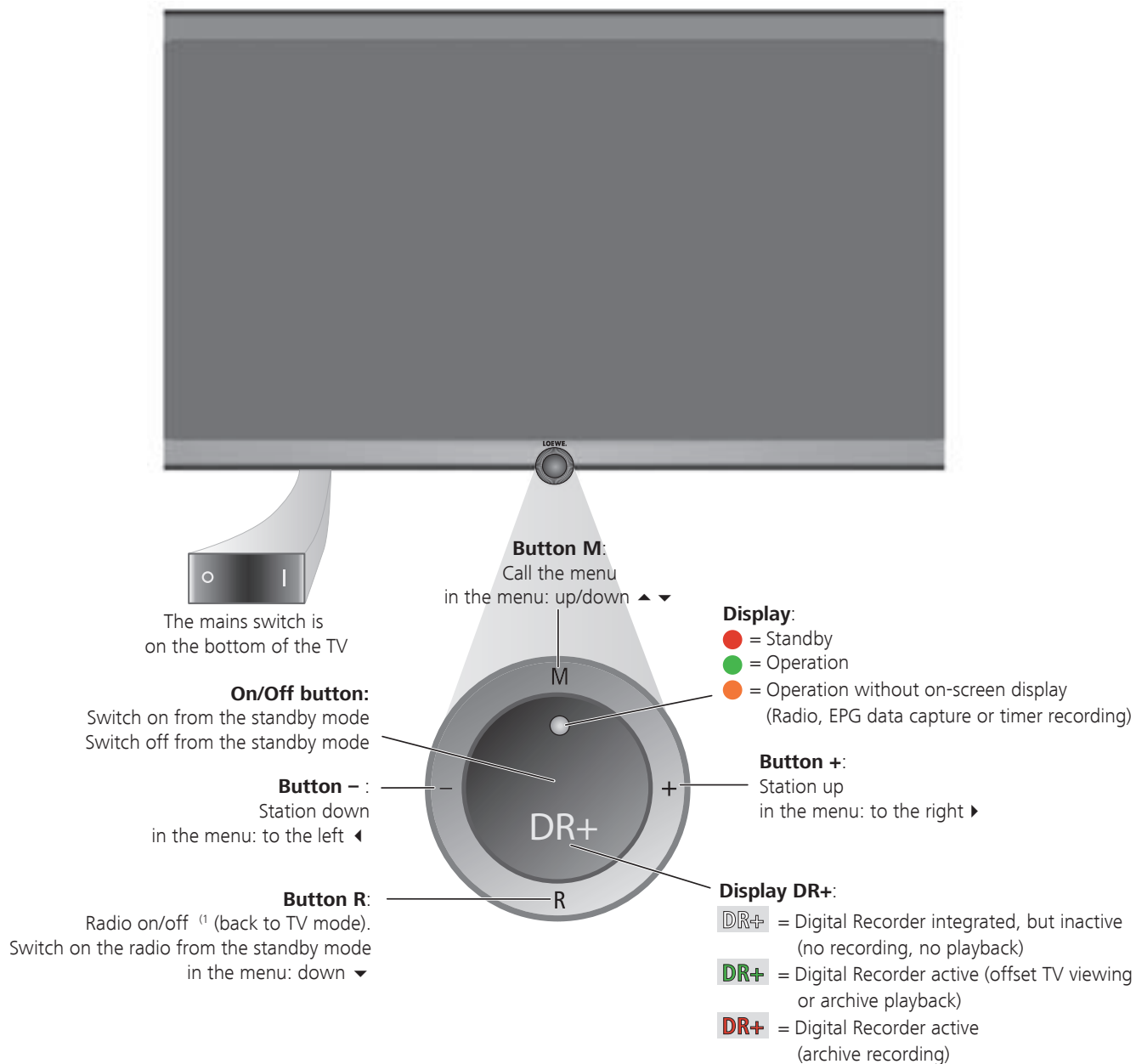

⁽¹⁾ Radio only for DVB reception, provided the station broadcasts this.
Otherwise switch over to an audio input.

Connections rear side of the device

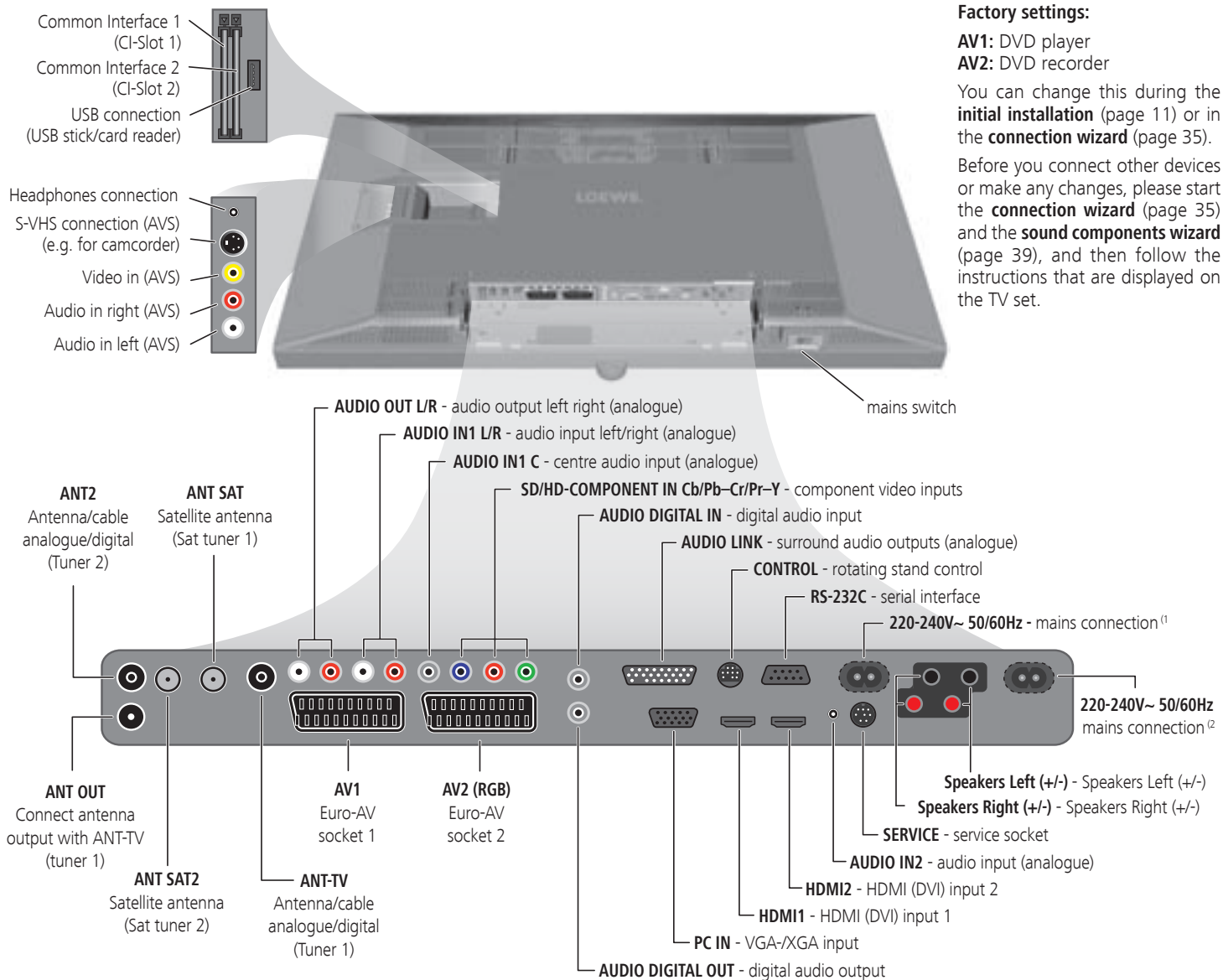

Factory settings:

AV1: DVD player

AV2: DVD recorder

You can change this during the **initial installation** (page 11) or in the **connection wizard** (page 35).

Before you connect other devices or make any changes, please start the **connection wizard** (page 35) and the **sound components wizard** (page 39), and then follow the instructions that are displayed on the TV set.

¹ mains connection for Individual Compose 40.

² mains connection for Individual Compose 46.

Welcome

Thank you!

At Loewe, we combine the highest standards of technology, design and user friendliness. This applies equally for TV, video and accessories.



Your new TV set is equipped for the TV standard "HDTV" (High Definition Television). With its high resolution screen and future-safe digital interfaces HDMI (High Definition Multimedia Interface), it offers the possibility of presenting HDTV programmes in outstanding picture quality.



HDTV is a worldwide, digital standard in the 16:9 format which revolutionises normal TV viewing. It is broadcast with an up to five times greater resolution than conventional signals and therefore creates an unexpectedly 3D image.

The TV set is equipped for digital reception. You can use the already frequently broadcast "everywhere television" (DVB-T) as well as digital cable (DVB-C) and digital satellite reception (DVB-S).

The Loewe Digital+ HD platform even allows dual reception of DVB-T, DVB-C and DVB-S.

The TV set is equipped with a Dolby Digital Decoder. You can connect a speaker system (e.g. Loewe Individual Sound) or active speakers and enjoy movie theater sound.

You can connect a card reader or a USB stick with digital photos to your new TV set's USB connection and view your photos via the integrated PhotoViewer software.

All the functions can be operated with the Loewe remote control.

We have designed the TV set in such a manner that you can easily operate it with the help of wizards and menus. Information about the menu settings is displayed automatically. You will quickly comprehend the context.

Scope of delivery

- LCD-TFT TV set
- Mains cable
- Wall mount WM54 (incl. installation instructions)
- Remote control Assist with two batteries
- Marketing and service card
- Operating instructions of the Digital Recorder
- This operating manual

No speakers are included in the scope of delivery for the "Individual Compose" TV set. You can custom configure the speaker equipment with your TV set and adapt it to your requirements. Ask your dealer in this regard.

About this operating manual

For many questions concerning the technology you will find an answer in the index of your TV set. If your question concerns TV set operation, you can access a function directly from the index of the TV set. Owing to this possibility, this operating manual only explains the most important operating steps.

The index/glossary from page 56 onwards gives explanations of certain terms used in the TV set and the operating manual.

Paragraphs beginning with the symbol  indicate important hints, tips or conditions for trouble-free operation.

Terms which you will find in the menu or printed on the TV are written in **bold** type.

In the functional descriptions, the necessary operating elements are arranged to the left of the text containing the handling instructions.

TV set equipment

See the rating plate on the rear of the set for the precise product designation. The precise features are listed in the **Integrated features** item in the index of the TV set (see page 14).

Trademarks

"Dolby", "Pro Logic" and the double D symbol are protected trademarks of Dolby Laboratories Inc. "DTS" and "DTS Digital Surround" is a trademark of Digital Theater Systems Inc.



The screen font "LoeweL2700" is based on the "Tavmjong Bah Arev (tavmjong.free.fr)" font, which in turn is based on "Bitstream Vera". Bitstream Vera is a trademark of Bitstream Inc.

Acknowledgements

Loewe Opta GmbH
Industriestr. 11
D-96317 Kronach
www.loewe.de

Printed in Germany
Date of issue 01/07-1.0 Be/Ps
TV-SW: 0.26.1 / DVB-SW: 0.18.5
© Loewe Opta GmbH, Kronach

All rights including translation, technical modifications and errors reserved.

Welcome

Operating convenience with wizards

This TV set offers user prompting with wizards that take you through the settings step-by-step.

You can return to the previous step or exit the wizard at any time.

The wizards in overview

Initial installation

The initial installation wizard helps you with the initial installation and connection of any existing equipment (see page 11).

Setting up the antenna

You enter in the antenna wizard which antenna signals are available to you. The antenna wizard is called in initial installation (see page 11). You can also call the antenna wizard in the TV menu under Connections → Antenna DVB → Antenna DVB-S or Antenna DVB-T.

Search wizard

If you want to search for new stations after the initial installation, or if you have set up your antenna for the first time, then you can handle this task with the help of the search wizard (see page 22).

Connecting external devices

The connection wizard ensures that all devices are correctly registered and connected. It is started automatically at the end of the initial installation wizard but can also be called separately (see page 35).

Connecting sound components

The sound component wizard ensures that the components which reproduce the TV sound are correctly registered, connected and set. It is started automatically at the end of the initial installation wizard but can also be called separately (see page 39).

Assist+

You can select the most important modes directly via a menu. Digital Recorder Archive, Radio, Favourites, PhotoViewer, Index and Personal Text Pages can be selected (see page 20).

Programming and managing recordings

The recording wizard can be called quickly via the timer overview and helps you to program a video recording with a video recorder, DVD recorder, or the integrated Digital Recorder (see page 46).

Station list

The station list is a list of all stored stations. You can also use the station list for switching stations conveniently (see page 16).

Software update wizard

The latest software for your TV set can be loaded via satellite or via USB stick (see page 33).

Info display and TV index

An information display for each menu item

The info display automatically shows content-based info texts in the upper part of the screen for each menu item. It forms a convenient operating system with the index (see page 14).

An index in the TV set

The index gives you an overview of the functional scope of your TV set. You can also start wizards and menu settings directly from here (see page 14).

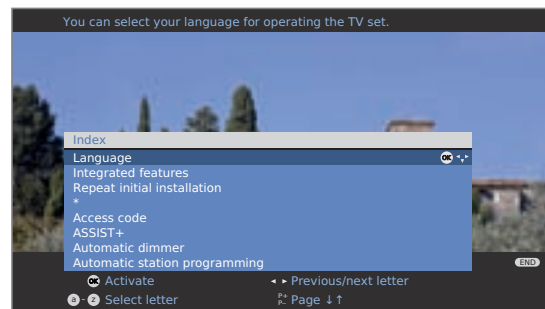

For your safety

For your own safety and to prevent unnecessary damage to your device, read and comply with the following safety instructions:

Proper use and environmental conditions

This TV set is designed exclusively for reception and reproduction of video and audio signals and is designed for living rooms or office facilities, and should not be operated in rooms with high **humidity**, such as a bathroom, or sauna, or where there is a high **concentration of dust** (e.g. workshops).

If the set is used outdoors ensure that it is protected against **moisture** (rain, splashing water, or dew). High humidity and dust concentrations cause leak currents in the device, which can cause a shock hazard if the device is touched, or a fire.

If you have brought the set into a warm environment from the **cold**, then wait for about 1 hour before switching it on to avoid formation of **condensation**.

Do not place any **objects** filled with **liquid** or burning candles on the device.

The manufacturer's warranty is only valid for use in the specified permissible environment.

Do not install the TV where there may be **vibrations**. This can lead to material overload.

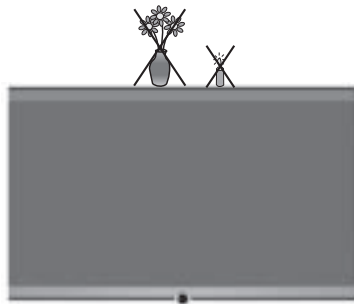

Transporting

Only transport the device in **vertical position**. Grasp the device on the upper and lower edges of the housing. Never set the TV down on the protruding control unit on the bottom of the TV set. This could damage the control unit.

If the set has to be put down during packing/unpacking, place the TV set with the entire front surface lying flat on a soft underlay such as a blanket or the felt from the packing material.

The LCD screen is made of glass or plastic and can break if not handled properly.

If the LCD screen is damaged and **liquid crystal** escapes, wear rubber gloves when moving the device. In the case of **skin contact** immediately wash thoroughly with water.

Power supply

The **wrong voltage** can damage the set. This equipment must only be connected to a mains power supply which has the same voltage and frequency as that specified on the rating plate; use the mains cable provided. The **mains plug** of the TV set must be easily accessible so that the device can be disconnected from the mains at any time. When you unplug the mains plug, do not pull on the **cable** rather pull on the plug housing. The cable in the mains plug could be damaged and cause a **short circuit** the next time it is plugged in.

Lay out the **mains cable** in such a manner that it cannot be damaged. The mains cable must not be kinked or laid over sharp edges, stepped on or exposed to **chemicals**; The latter also applies for the entire equipment. A mains cable with damaged insulation can cause **electrical shock** and is a **fire hazard**.

Air circulation and high temperatures

The **vent slots** on the **rear panel** of the set must always be kept free. Please do not place newspapers or cloths on/over the TV.

Ensure that there is at least 10 cm free space on the sides and above the set for air circulation, if the set is placed in a **cabinet** or on a **shelf**.

Like any electronic device, your TV set requires air for cooling. Obstruction of the air circulation can cause fires.

The set is suitable for different installation solutions. See the instructions for assembly for the different installation solutions.

Stand the TV set with the table or floor stand only on a level, **sturdy, horizontal base**. Particularly ensure that the set does not protrude to the front when placed in or on pieces of furniture.

Set up the device where it is not exposed to direct **sunlight** and where it is not exposed to additional warming through **heating elements**.

Prevent **metal items**, needles, paper clips, liquids, wax, or similar items, from getting into the interior of the device through the **vent slots** in the rear panel. Such objects can cause **short circuits** in the set, which could possibly cause a fire.

If something should get into the **interior of the set** then immediately unplug the mains plug of the device and contact **customer service** for more information.

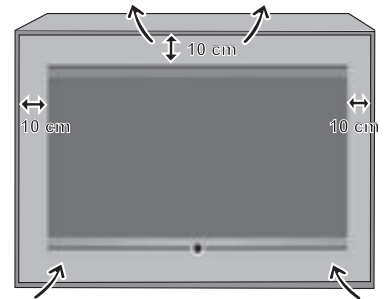

For your safety

Repairs and accessories

Never remove the back of the TV set yourself. Only have your TV device repaired or serviced by **authorised television technicians**.

Only use **original accessories** such as Loewe stands if possible (see Accessories on page 55).

Supervision

Do not allow **children** to use the TV set without supervision or to play in the immediate vicinity of the TV set. The set could tip over, be pushed off or pulled down from the stand surface and injure someone.

Do **not** allow the switched-on TV set to run **unattended**.

Volume

Loud music can lead to ear damage. Avoid extreme volume especially over long periods and when using headphones.

Cleaning

Clean the TV set, the screen, and the remote control unit with a soft, moist, and clean cloth, only, **without any aggressive or scouring cleaning agents**.

Thunder storms

Pull out the **mains plug** and all connected **antenna cables** from the TV set in a thunderstorm. Overvoltage caused by **lightning** can damage the set via the antenna system, as well as via the mains. The mains plug and all connected antenna cables should also be pulled out during long periods of **absence**.

Note on the LCD screen

The TV set you have purchased with LCD screen satisfies the most rigorous quality requirements and has been inspected relative to **pixel errors**. In spite of the utmost care in manufacturing the display, for technical reasons the possibility that some **pixels** will have defects cannot be 100% excluded. Please understand that these types of effects, as long as they are within the standard of specified limits, cannot be considered as a device defect in terms of the guarantee.

Environmental protection

Energy consumption

Your TV set is equipped with an eco-standby power supply. In the standby mode, the power consumption drops to low power (see technical data on page 54). If you want to save even more energy then switch the device off with the mains switch. However note that in this case, EPG (Electronic Programme Guide) data will be lost, and it may be that programmed timer recordings **cannot** be executed via the TV device.

Packaging and box

You have made a decision to purchase a high-quality technical product with a long service life. For disposal of the packaging, in accordance with national legislation we have paid a fee to a commissioned recycler to pick up the packaging from the dealer. Nevertheless we recommend keeping the original box and **packaging material** on hand so that the device can be transported with optimal protection if necessary.

The set



The EU directive 2002/96/EC regulates the proper way to recycle, handle and utilise used electronic devices. **Old electronic devices** consequently must be disposed of separately. Please do **not** dispose of this device in normal **household trash!**

You may return your used set free of charge at designated recycling centres or at your specialist dealer whenever you purchase a new, comparable set. Additional details about return (also for non EU countries) are available from your local municipal authorities.

Batteries



The batteries supplied as initial equipment do not contain any pollutants such as cadmium, lead, or mercury. Used batteries should **no longer** be disposed of in the **domestic waste** according to the Battery Ordinance. Dispose of your batteries at no charge in the **collection containers** which are set up for this purpose in retail stores.

Initial installation

Installing the TV set

First prepare the chosen installation solution for your TV set. See the installation instructions of the wallmount supplied. See Accessories (page 55) for other installation possibilities.

Removing the protective foil

Slowly and carefully remove the protective foil on the trim.



Preparing the remote control unit

Inserting or replacing batteries

Press the embossed arrow and push down the battery compartment cover.

Insert two alkaline manganese LR 03 (AAA) batteries; ensure that the + and – poles are correctly positioned!

Slide the cover up from below.



Adjusting the remote control for operating the TV set

TV

Press the **TV button**.

See page 50 to learn about operating other Loewe devices.

Connecting the TV set

Connecting to the mains

► Note the position of the mains connection in Individual Compose 40 / 46.

Remove the cover for the connections.

Connect the TV set to a 220-240V outlet:

First plug the small plug of the mains cable into the mains connection on the rear of the TV, then plug the large plug into a mains power outlet.

Connecting the antenna

Analogue / DVB-C / DVB-T antenna:

Plug the antenna plug of antenna system, cable system, or room antenna into the **ANT2** socket.

The connecting cable between **ANT-TV** – **ANT OUT** is plugged at the factory.

Satellite antenna:

Connect an antenna plug, e.g. from the antenna change-over switch or from the twin-LNC of the satellite system to the sockets **ANT-SAT** and **ANT-SAT2**.

When connecting only one SAT antenna cable, connect it to **ANT-SAT**.

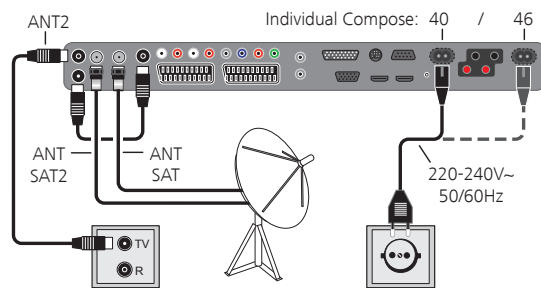

Connections on the back of the set (see also page 5).

Replace the cover over the connections.

Connecting speakers

How to configure and connect TV speakers, speaker systems or active speakers is described from page 39.

Receiving coded stations

When using a CA module and a Smart-Card to receive coded stations, please observe the handling of the CA module (see page 32).

Initial installation

Turning the set on/off

Switching the TV set to standby mode



Activate the mains switch on the bottom left of the set.

The display in the control panel on the front of the set will be illuminated red, the set is now in standby mode.

Switching the TV on/off on the control unit

Press the on/off button in the middle for about 2 seconds to switch the TV set on/off.

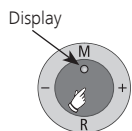

Meaning of the display colour:

Red: Standby mode

Green: TV set is switched on

Orange: Radio mode, TV set receives EPG data or timer recording active

Switching the set on with the remote control



Press the **on/off** button.



or:
numeric buttons (0–99).



or:
TV button.



or:
OK button – station list is called.

Switching the set off with the remote control



Press the **on/off** button.

► Before switching off the set with the mains switch, we recommend you to switch it to standby mode.

Switching on/switching to radio mode

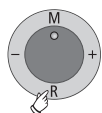

Press **R** on the TV control unit.



or:
RADIO button on the remote control.
(radio mode, see page 34).

First installation wizard

First installation after switching on for the first time

This wizard starts automatically after the set is switched on for the first time, however it can also be called later manually in the TV index, see **Repeat initial installation** on page 14.

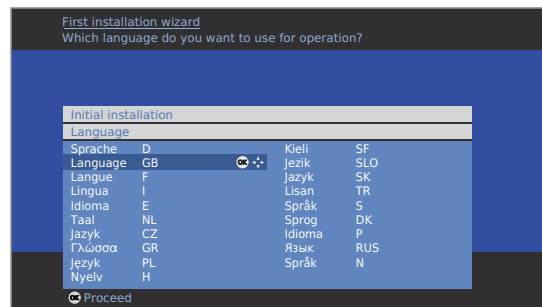

The first step with the wizard starts when selecting the language for the user prompts. From this point on follow the instructions on your TV set.

Brief explanation of button functions:



Press the ring (up, down, left, right) to move the cursor and to select settings.



By pressing the **OK** button a setting is confirmed and you will go to the next step.



You can select or remove several items with the **yellow button** (see example below).

When an element is selected, it is marked by a checkmark .



Use this button to go back one step.



Exit the wizard with the **END** button (if available).

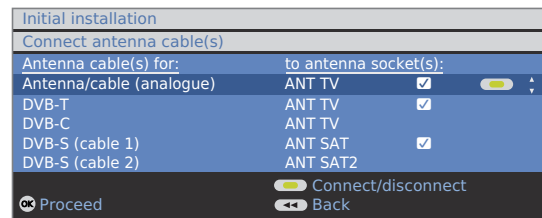

An example of multiple selection using the **yellow button**.

continued on the next page →

Initial installation

Explanations of the setting possibilities:

- Location of TV set Select the country for country-specific pre-settings.
- Antenna selection **Antenna/cable (analogue):** analogue stations via cable/antenna
DVB-T: digital, terrestrial stations
DVB-C: digital stations via cable
DVB-S (line 1): digital stations via satellite
DVB-S (line 2): digital stations via satellite
- DVB-T:** If you are using an active antenna, then select **yes (5V)**
Antenna for the antenna power supply.
- DVB-C:** The conventional settings will be derived from the selection of set location. Only change this if you know other symbol rates and modulation types or if you have to specify the network ID for your cable network (information available from your cable network provider). If you want to run the station search independently of the channel grid, select frequency search for the search method.
- DVB-S:** Select which satellite(s) you receive from a list. For more than one satellite, select the type of your changeover system switch or communal satellite system additionally. Ask your dealer in this regard.
- High band Specify here whether the high band of the selected satellite is to be searched in addition to the low band.
- LNC frequencies Low Band / High Band Normally, you do not need to change the values for high and low band, unless the LNC (LNB) of your satellite system uses a different oscillator frequency (important for the frequency display).
After you have made these settings, you should receive the picture and sound of the selected satellites (only with Astra1 and HOTBIRD).
- Symbol rates The symbol rates are specified by the satellite provider and normally do not need to be changed.
- Favoured signal source Select the signal source that provides the stations to be on top of your station list (starting with station slot 1).

- Start search Start the automatic station search with **OK**.
First TV stations, then radio stations are searched for. The stations found in the automatic search are divided into the appropriate station blocks depending on the previously selected antenna cables (signal sources). Subsequently the stations can only be re-sorted within these blocks. At the beginning of the station list you will find the block with the stations of the preferred signal source. Any mixed sorting of stations from different signal sources is only possible with the favourites list.

- Connecting additional devices** In conclusion the connection wizard and the sound components wizard will start; with their help you can register and set your video devices, decoders, speaker system, or a HiFi/AV amplifier and connect them to the TV set. DVD players and DVD recorders are already registered at the factory.
You can start the connection wizard and the sound components wizard manually later and add new devices. Further information is available from page 35 (Connection wizard) and page 39 (Sound components wizard).

- Digital Link Plus If you have registered and connected a recorder in the connection wizard, the Digital Link Plus transmission begins at the end of the sound components wizard. If a Digital Link Plus capable recorder is connected, the station list of the analogue stations is transmitted to the external recorder.
You can also call Digital Link Plus under **TV menu → Connections → Digital Link Plus**.
If you have not connected a Digital Link Plus capable recorder, you can abort the transmission.

Explanations of the DVB-T antenna:

- Room antenna With good reception conditions a room antenna can be used for DVB-T (socket **ANT2**).
- Active antenna Under less favourable reception conditions, it is advisable to use an active antenna which has to be set accordingly in the initial installation or in the **TV menu → Connections → Antenna DVB → Antenna DVB-T** (see DVB-T antenna on this page).
- Unidirectional antenna If the location is outside of the normal transmission range then a directional antenna can be used to improve reception quality.

Initial installation

Positioning/aligning DVB-T antenna

If you are receiving one or more DVB-T stations with picture and sound interference then you should change the installation location and alignment of the antenna. Ask your dealer to tell you which channels are used to broadcast the DVB-T stations in your region.

- ➡ In normal TV mode, without other displays. A DVB-T station is received and selected.

MENU

Call **TV menu**.



- ◀ ▶ Select **Settings**,
 - ▼ go to the menu line below.
- ◀ ▶ Select **Stations**,
 - ▼ go to the menu line below.
- ◀ ▶ Select **Manual adjustment**,
OK call manual adjustment.

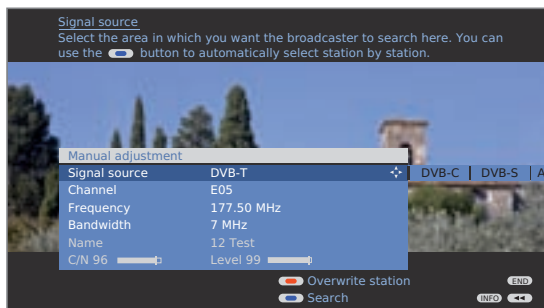

The signal source is already on DVB-T due to the station preselection.

Position and align the antenna in such a manner that maximum values for **C/N** and **Level** are obtained.



Blue button: Start search.

Search for DVB-T stations one after another and compare values for **C/N** and **Level**.

Then position/align the antenna to the weakest station so that maximum values for **C/N** and **Level** are obtained.

Thereafter perform an automatic search for all DVB-T stations, see page 22.

Explanation of the setting possibilities:

Bandwidth Depending on the selected channel and country the associated bandwidth of 7 or 8 MHz will be set automatically.

Operating convenience

General information on menu operation

Use the **MENU button** to call menus for the various modes. Additional menus can be called directly with the remote control.

The menus are displayed at the bottom of the screen. At the top you get additional information about the selected menu item (see info display on page 14).

- ➡ In normal TV mode, without other displays.

MENU

Call **TV menu**.

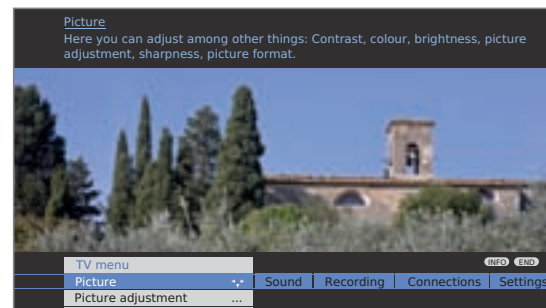

Example: Selecting and executing functions



- ◀ ▶ Select **Picture**,
 - ▼ go to the menu line below.
- ◀ ▶ Select **Brightness**,
 - ▼ go to the menu line below.
- ◀ ▶ Set **Brightness**.
 - ▲ Go to the **Brightness** menu line to make other picture settings.
- ◀ ▶ Select **more ...** ,
OK call **more ...** functions.
- ◀ ▶ Select **Auto format**,
 - ▼ go to the menu line below.
- ◀ ▶ Select **on / off**.

END

Conclude the settings.

Inputs via numeric buttons



Letters have to be entered for specific functions. Like using a mobile phone keypad (1 to 9), press a numeric button until the desired character appears.

The available letters are imprinted on the individual numeric buttons.

Operating convenience

The info display

The info display shows a content-based info text for each menu item at the top edge of the screen to help you in making the settings. In conjunction with the index it creates a convenient control system.

⇒ A menu is displayed.

INFO

The factory setting makes the info display appear automatically for each menu item. In this case you can temporarily hide the info texts with the **INFO** button.

The automatic info display can be hidden via a menu setting. Then it can be displayed once by pressing the **INFO** button.

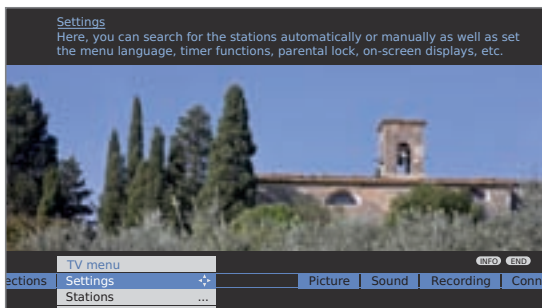

You can tell if an info text is available by an **INFO** icon that is shown in the lower right above the menu bar.

Permanently display or hide the automatic info display

Once you have become familiar with how to operate the TV set, you can switch off the automatic info display.

⇒ In normal TV mode, without other displays.

MENU



Call **TV menu**.

- ◀ ▶ Select **Settings**,
▼ go to the menu line below.
- ◀ ▶ Select **Miscellaneous**,
▼ go to the menu line below.
- ◀ ▶ Select **On-screen displays**,
▼ go to the menu line below.
- ◀ ▶ Select **Automatic info**,
▼ go to the menu line below: **yes / no**.

The index in the TV set

You can start all wizards and many operating functions directly from this point. The complete function scope of the TV set can thus be easily understood.

Alphabetic sorting is preceded by the items **Language**, **Integrated features** and **Repeat initial installation**.

Call index

⇒ In normal TV mode, without other displays.

INFO

Call **Index**.

You will see an info text for the highlighted keyword in the info display.

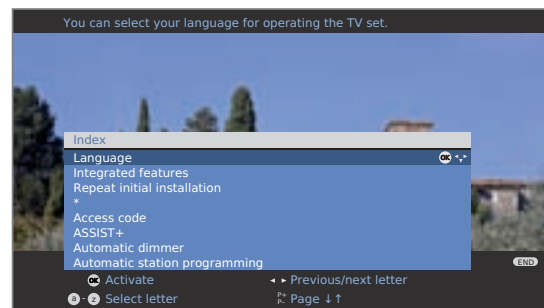

If an OK symbol appears in the marked line, this function can be called directly with **OK**.

Selecting a keyword



Enter initial letters with the **numeric buttons** like with a mobile phone keypad (see page 13).

or go with:



- ◀ ▶ to the preceding / next letters,
- ▼ ▲ from line to line,



P+/P- scroll backwards or forwards in whole pages.

Example: You want to have the TV set switch off automatically at a specific time:
Select the keyword **Switch off** → **Automatic**, with **OK** you will go to the setting.

Operating convenience

TV menu – Overview diagram

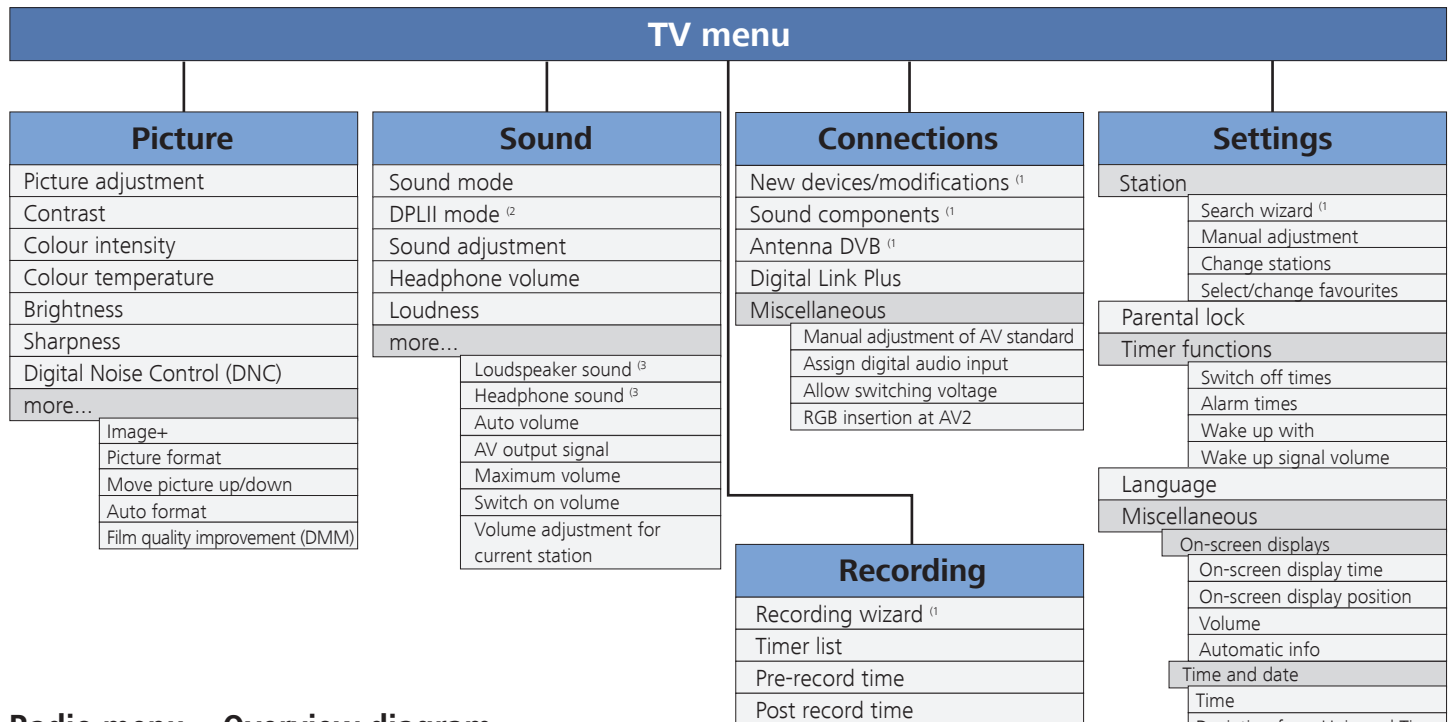

Radio menu – Overview diagram

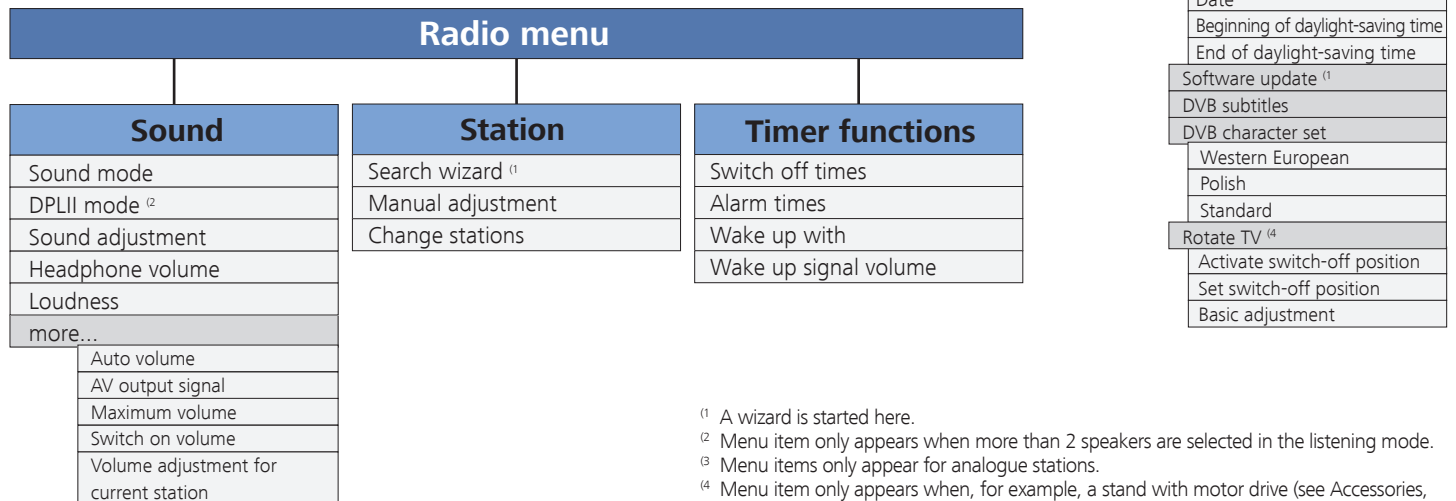

⁽¹⁾ A wizard is started here.

⁽²⁾ Menu item only appears when more than 2 speakers are selected in the listening mode.

⁽³⁾ Menu items only appear for analogue stations.

⁽⁴⁾ Menu item only appears when, for example, a stand with motor drive (see Accessories, Installation possibilities, page 55) is used.

Daily operation

Select station

With the keys P+ and P- on the remote control



P+/P- station up/down.

The station display with sound identification is displayed briefly.

➡ If favourites are selected, the station is switched over in the favourites list with **P+/P-** (see page 17).

➡ The symbols for the sound identification are described on page 21.

➡ If there are additional languages or DVB subtitles for DVB stations, then language and subtitle selection is shown below the station display. See also page 21: Additional selection possibilities for DVB stations.

With the numeric keys of the remote control



long

1-digit stations

Keep the **numeric button** pressed for one second, the station changes immediately.

or:

Press the **numeric button** briefly, the station changes after 2 seconds (changes immediately in case up to 9 stations are stored).



short short long

2-digit and 3-digit stations

Press first (and second) **numeric button** briefly.

Keep the last **numeric button** pressed for one second, the station changes immediately.

or:

Press all the **numeric buttons** briefly, the station changes after 2 seconds (changes immediately up to 99 or 999 stored stations).



all short

4-digit stations

Press all four **numeric buttons**, the station changes immediately.

➡ If favourites are selected, the station in the favourites list is switched to with the numeric buttons (see page 17). A maximum two-digit station input is possible.

➡ If you select an unoccupied station slot, the next available station is switched to.

With the station list

➡ In normal TV operation, without further displays, no favourites selected:

OK call Station list.



Sorting numerically



P+/P- scroll in the pages of the station list.



▲ ▼ ◀ ▶ Mark stations.

or:

Enter the number of the station with the **numeric buttons**. The marked station is shown as a small picture.



OK the marked station is called.



Blue button: Changes sorting from **numeric** to **alphabetic**.

Sorting alphabetically

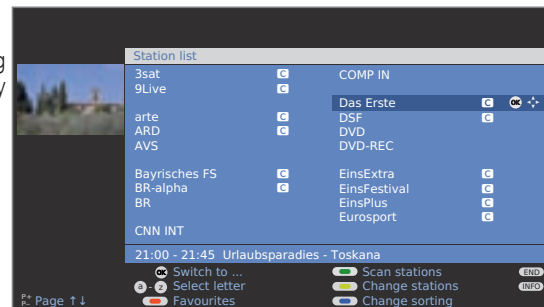

Enter initial letters with the **numeric buttons** like with a mobile phone keypad (see page 13). The first station for the specified letters is marked.

▲ ▼ ◀ ▶ Mark stations.

OK the marked station is called.



Daily operation

With the favourites lists

You can save and call your favourite stations in 6 favourites lists (e.g. for multiple users). Each favourites list can contain up to 99 stations. After initial installation, 10 stations from the station list are already stored in the first list. Change the favourites list to suit your requirements (see **Put together – changing favourites lists** on page 24).



► In normal TV mode, without other displays:

OK calls the station list.



Red button: calls the favourites list.

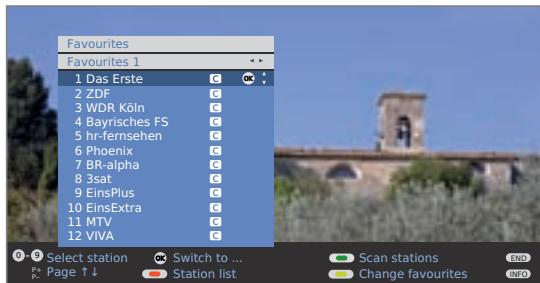

Select station directly with **numeric buttons**.

Or:



P+/P- scroll in the pages of the favourites list.



▲ ▼ Mark stations.

OK the marked station is called.

◀ ▶ Select other favourites list

► Other favourites lists can only be selected if they also contain stations.



Red button: Back to the station list.

Green button: Scan all stations of the currently selected favourites list.

Yellow button: Change the favourites lists, see page 24.

Explanation of the favourites lists

The selection made with the red button (station list or favourites list) is retained until the next call. All inputs then refer exclusively to the currently selected favourites list.

If favourites are selected, the name of the favourites list appears after the station name.

Explanation of the icons following station names:

- T** Digital DVB-T station (terrestrial via antenna)
- C** Digital DVB-C station (via cable)
- S** Digital DVB-S station (via satellite)
- 0-9** Coded station

Select video source

► Please ensure that the appropriate devices have also been registered with the device connection wizard (see page 35).

Via AV selection



Call **AV selection**.



◀ ▶ Select desired device or connection,

OK to switch over.

A signal from the selected video source should now be visible.

Via station list



► In normal TV mode, without other displays:

OK call the station list.

In numerical sorting the connections or devices are always at the beginning of the list.

In alphabetic sorting, the connections or devices are sorted in alphabetically.



▲ ▼ ◀ ▶ Select connection/device.

OK to switch over.

Daily operation

Adjusting the sound

Switching sound off/on



Sound off;
Sound on: Press button again or set volume **V+**.

Setting the volume

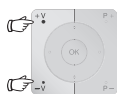

V+ / V- volume louder / quieter.

The volume bar will be shown briefly if no other menu is displayed.

Setting the sound mode



Call **Sound mode**.



◀ ▶ Select the number of speakers you want to hear.

Additional sound settings for volume adjustment and for Sound mode:

► As long as you can still see the volume bar or the selection of speakers for sound mode:



▲ Call additional sound settings.

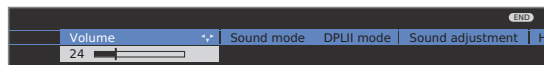

- ◀ ▶ Select sound setting,
- ▼ Go to the menu line below.
- ◀ ▶ Make changes.

Sound settings via the TV menu

► In normal TV mode, without other displays.



Call **TV menu**.



- ◀ ▶ Select **Sound**,
- ▼ go to the menu line below.
- ◀ ▶ Select desired sound setting,
- ▼ Go to the menu line below.
- ◀ ▶ Make changes.

Explanations of the sound settings:

Sound mode Select the number of speakers you want to hear. The selection depends on the connected sound components (from page 39) and on the transmitted audio signal.

► If the number of speakers appears in brackets, the sound of missing speakers is transmitted by the existing speakers (virtual).

optimal The momentarily reproduced audio signal is output with the ideal number of speakers.

1◀ Play centre sound or mono (left/right).

2◀ Play front sound (L/R stereo).

3◀ Play front and centre sound.

4◀ Play front and surround sound.

5◀ Play front, surround and centre sound.

► You can also enter the number of speakers with the numeric buttons of the remote control.

Amplifier ▶ play via an external HiFi amplifier. Selection is only possible if an amplifier has been selected in the sound components wizard.

Sound adjustment Speech, Classical, Pop, Custom music, and Custom film sound.

Headphone vol. Adjust the headphones volume.

Loudness Proper boost of bass and treble tones at low volume.

DPLII mode Here you can make Dolby Pro Logic II sound settings for movie, music, matrix and personal settings. Menu item only appears when more than 2 speakers are selected in the sound mode.

more ... call with **OK**.

Sound Speakers/Headphones Selection possibility Mono/Stereo or Sound 1 or Sound 2 for two-sound broadcasts separately for speakers and headphones. Only available for analogue stations.

Auto Volume Reduces volume differences, e.g. for advertisements that are too loud.

AV output signal Sound selection for two-sound broadcasts.

Maximum volume Determining the maximum volume that can be set.

Switch on volume Specify the volume that is set when switching on the TV set with the mains switch. This does not affect switching the set on from standby mode.

Volume adjustment for current station The volume can differ according to the individual stations. If the sound is too loud or too quiet in relation to other stations, adjust the volume. When the menu is open, you can select the stations one after another with **P+/P-** and adjust every single station conveniently.

Daily operation

Adjusting the picture



Call **TV menu**.

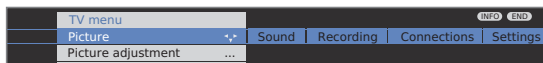

- ◀ ▶ Select **Picture**,
- ▼ go to the menu line below.

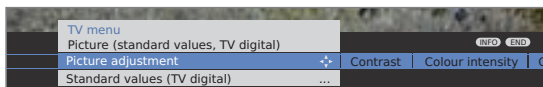

- ◀ ▶ Select the desired picture function,
- ▼ go to the menu line below.
- ◀ ▶ Make changes.

Explanations of the picture settings

Picture adjustment Switches the picture parameters between standard and personal values.

Contrast Adjust contrast.

Colour intensity Adjust the colour.

Colour temperature Set warmer or cooler tints for the picture.

Brightness Adjust the brightness of the picture.

Sharpness Adjust the contour sharpness of the picture.

DNC Removes or reduces the signal noise in the picture.

more ... Call with **OK**.

Image+ Image improvement on/off and demo mode.

Picture format Setting possibilities for the picture format (see page 20).

Vertical picture hold Move picture vertically (see page 20).

Auto format With Auto format switched on, the TV set recognises the picture format for Cinemascope or wide screen movies and adapts accordingly.

DMM Reduce image jolting.

Standard values / personal values for picture adjustment



Call **TV menu**.



- ◀ ▶ Select **Picture**,
- ▼ go to the menu line below.

- ◀ ▶ Select **Picture adjustment**,
- ▼ go to the menu line below.



- ◀ ▶ Select desired values for picture,
- OK** call selected values for picture.

Explanations for picture adjustment

Custom adjustments of contrast, colour intensity, colour temperature, brightness, sharpness and digital noise suppression are saved in the personal values. There are separate personal values for every signal source (TV analog, TV digital, HD analog, HD digital, PC, PhotoViewer).

By selecting **Standard values** the picture parameters are reset to factory values for the respective currently active signal source.

For an explanation of the signal source; see glossary: **Signal input groups**.

In the index of the TV set, all the picture and sound adjustments can be reset to the factory values for all signal sources in one step under **Reset picture/sound** or **Initialise picture/sound** or **Factory settings picture/sound**.

Operation without remote control

Changing the station on the TV set

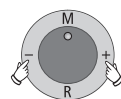

+ / - Station up/down.

Switching radio on or off or switching to radio

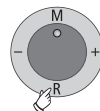

R Radio on / off or switching between TV and radio.

Calling the TV menu on the set

▣ **Service** is for customer service personnel only.

M call **Direct control on TV set** menu,

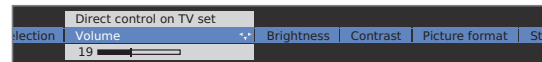
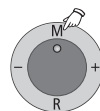

- / + select function.

M or **R** go to the menu line below,
- / + make changes.

M move up one menu line,
- / + select other function.

Daily operation

Button functions

Each operating mode of the TV set (TV, Radio, Teletext, EPG, or Picture in Picture) has a separate menu and separate functions for the coloured buttons. The assignment of the coloured buttons is illustrated in the description of the individual operating modes.

Below, some of the button functions are listed which you need for daily operation of your TV set.

Functions of the coloured buttons in TV mode

 **Red button:** Digital Recorder: DR archive on/off.

 **Green button:** Call menu Teletext subtitles.

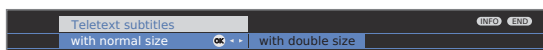

◀ ▶ Select size of the Teletext subtitles,
OK show Teletext subtitles.
(display only if subtitles are available).



END: Teletext subtitles off.

 **Yellow button:** Go to the last viewed station.
Use this button to quickly switch back and forth between two stations.

 **Blue button:** Show programme info.



Permanent display of time



Press twice in rapid succession, the time is permanently displayed.



⌚ or **END:** Hide time.

Selecting the picture format



Press the picture format button until the desired picture format is marked or



◀ ▶ to select the desired picture format.

The **Panorama** picture format can be switched between proportionally correct and format filling reproduction. Dark margins are visible on the right and left of the picture in proportionally correct reproduction.

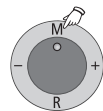

Switching over: Keep the **M** button on the set pressed, at the same time press the **Picture format** button on the remote control briefly.



Resetting: Press the same button combination again.

Explanations of the picture formats

► Setting possibilities depend on the displayed picture content.

16:9 Proportionally correct display of 16:9 programmes.

4:3 Proportionally correct display of 4:3 programmes.

Panorama Proportionally correct or format filling reproduction of 4:3 broadcasts on the 16:9 screen. Station logos and subtitles remain intact. See above for switching Panorama mode.

Cinema Proportionally correct, format filling display of 4:3 broadcasts on 16:9 screens.

Zoom Proportionally correct display. Maximum picture magnification.

PALplus Is a 4:3-compatible 16:9 picture broadcast supplied by the station which is detected automatically.

If a high-resolution picture signal is displayed on the TV set or fed in via the interfaces PC IN, HDMI1/DVI, HDMI2/DVI or COMP. IN, the picture formats 16:9 TV, 4:3 TV as well as 16:9 PC, 4:3 PC and Zoom can be set.

Move picture vertically

► In normal TV mode, without other displays:



▲ ▼ Move picture up/down.

To show subtitles or news tickers which have been cut off, the picture can be moved up or down in the picture formats **Panorama**, **Cinema** and **Zoom** (not with high resolution signal) with the **arrow buttons** ▲ ▼.

Call Assist+



Call the Assist+ menu.



◀ ▶ Select DR archive, Radio, Favourites, PhotoViewer, Index, Personal text pages.

OK calls the function.



Daily operation

Status display

➡ In normal TV mode, without other displays:

END

END: Show / hide status display.

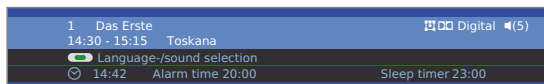

In the top two lines you will see the number and name of the station, the title of the programme currently running (if available) and the sound identification.

The time and, if activated, the alarm time and switch-off time are displayed at the bottom.

Explanations of the symbols for sound identification:

Transmitted audio signal:

- Mono** Mono audio transmission analogue
- 2-sound** Two-sound transmission (Sound1/Sound2) analogue
- Stereo** Stereo sound transmission analogue or digital (PCM)
- DD Digital** Dolby Digital sound transmission (DD)
- dts** dts sound transmission
- MPEG** MPEG sound transmission
- DD ProLogicII** Dolby Pro Logic II

Transmitted audio channels:

- DD / dts 1.0 / mono
- DD / dts / MPEG 2.0
- DD / dts
- DD / dts
- DD / dts
- DD / dts
- DD / dts
- DD / dts
- DD / dts
- DD / dts

Selected listening mode:

- 1** Play centre sound or mono (left/right).
- 2** Play front sound (L/R stereo).
- 3** Play front and centre sound.
- 4** Play front and surround sound.
- 5** Play front, surround and centre sound.

➡ If the number of speakers appears in brackets, the sound of missing speakers is transmitted by the existing speakers (virtual).

Additional selection possibilities for DVB stations

In the status display additional selection possibilities can be offered for specific programmes depending on the DVB programme provider.

➡ If during the status display you press one of the **coloured buttons** or the **TEXT button** then the associated selection menu will be displayed.

The following options are possible:

Red button: Channel selection for multi-channel providers

Green button: Language/audio selection

Yellow button: Time selection

Blue button: Protection of minors

TEXT: DVB subtitles

The selection menus are only available as long as the status display is shown. However you can call them again by pressing the **END button**.

Explanations of the selection possibilities

DVB subtitles The subtitle selection refers exclusively to DVB subtitles and is not offered by all stations. Many stations only transmit subtitles by teletext.

You can make general settings for DVB subtitles under **TV menu → Settings → Miscellaneous → DVB subtitles**.

New programme The selection line is automatically displayed briefly, if a new programme begins with options that are different from those of the previous programme, or if you switch to a different station.

Managing stations

TV stations

Various options for managing stations are available via the TV menu. For example the description for TV stations. For radio stations the same applies, except that the radio menu is called in radio mode (see also page 34).

⇒ Station management is not possible if a programmed timer recording is still pending.

Search/update stations – Search wizard

In the search/update with the search wizard, new stations are searched for which are not yet stored.

⇒ You have to repeat the initial installation (see page 11) and automatically search for new ones if you want to delete all the existing stations and automatically search for new ones.

MENU



Call **TV menu**.

- ◀ ▶ Select **Settings**,
▼ go to the menu line below.
- ◀ ▶ Select **Stations**,
▼ go to the menu line below.
- ◀ ▶ Select **Search wizard**,
▼ go to the menu line below.

In the upper info text the current search settings will now be displayed:

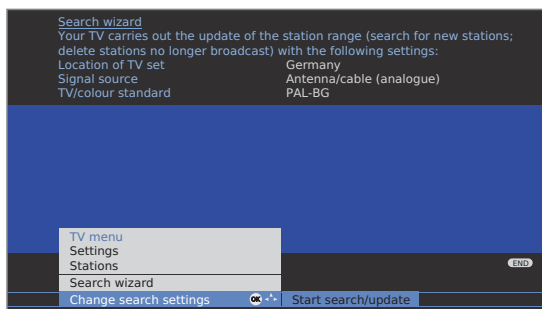

If you want to change these search settings:



- ◀ ▶ Select **Change search settings**,
OK wizard prompts search settings.

If you agree with these settings:

- ◀ ▶ Select **Start search/update**,
OK start search.



Red button: Abort current search/update.

Explanations of some search settings:

Set location Select the country for country-specific defaults and station sorting.

Signal source Select antenna, cable, or satellite here, depending on where you want to search for new stations.
At this point you can also call a configuration of the DVB-T and DVB-S antennae via the yellow button (see page 12).

Antenna/cable: With selection of set location the conventional TV standard/colour standard is the default. This should only be changed if stations with other standards are to be searched.

DVB-T If you want to run the station search independently of the channel grid, select **frequency search** for the search method.

DVB-C With the selection of set location the conventional settings will be preset. Only change this if you know other symbol rates and modulation types or if you have to specify the network ID for your cable network (information available from your cable network provider).

If you want to run the station search independently of the channel grid, select **frequency search** for the search method.

DVB-S The symbol rate is specified by the satellite provider and normally does not need to be changed.

Search/update stations – Search ended

After the station search has ended, the number of new found stations is displayed.



OK to continue.

If new stations are found, these are displayed with the appropriate station number.

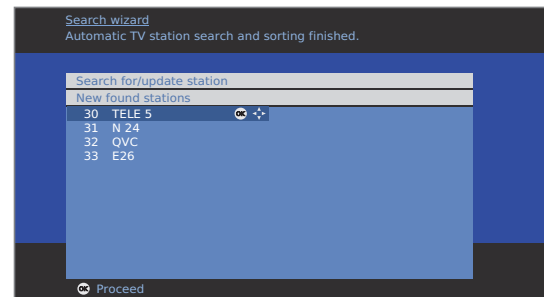

OK to continue.

END

END: to exit search wizard.

Managing stations

Search/update station – manual search



Call **TV menu**.



- ◀ ▶ Select **Settings**,
▼ go to the menu line below.
- ◀ ▶ Select **Stations**,
▼ go to the menu line below.
- ◀ ▶ Select **Manual adjustment**,
OK call input box.

You can enter or edit the station data in the following lines:

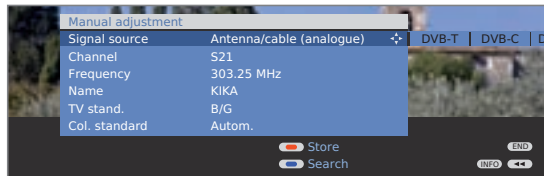

Or:



Blue button: Starts **Search** and searches for next station.

Red button: Stores station.

⇒ Only stations for the selected signal source can be saved which do not yet exist in the station list.

⇒ Stations which already exist in the station list for the selected signal source are displayed with their station numbers and names on a grey background. These stations can only be overwritten with the **red** button.

Explanations of some search settings:

Various settings are possible depending on the selected signal source. Some settings have already been explained in the initial installation (see page 12 onwards).

Signal source	Selection of range in which you want to search for the station.
Channel	Direct input of channel.
Frequency	Direct input of station frequency.
TV stand.	Input of station TV standard. (B/G, I, L, D/K, M, N) Ask your dealer in this regard.
Col. standard	Input of the station colour standard. (PAL, SECAM, NTSC-V, PAL60, Autom.) Ask your dealer in this regard.

Change, delete, move, rename, restore stations

⇒ **Change stations** can also be called via the station list (page 16).



Call **TV menu**.



- ◀ ▶ Select **Settings**,
▼ go to the menu line below.
- ◀ ▶ Select **Stations**,
▼ go to the menu line below.
- ◀ ▶ Select **Change stations**,
OK call list of stations.

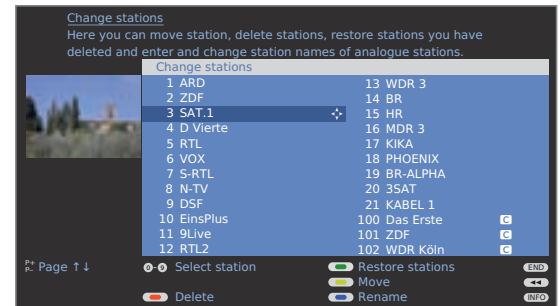

In this menu you can delete, move, rename or restore stations.

◀ ▶ ▲ ▼ or **numeric buttons:**
to select the appropriate station.
Scroll with **P+/P-** if necessary.

Delete station



Red button: Activates **Delete** station.



▲ ▼ mark several stations if needed,
OK to execute the delete.

Move station / Change order

⇒ Stations can only be resorted within their signal source block.



Yellow button: Activates **Move** station.



▲ ▼ mark several stations if needed,
OK to end marking.
▲ ▼ Selection insert position from which the marked stations are to be inserted,
OK to execute the move.

Managing stations

Rename station

► DVB stations for which the station name is also broadcast cannot be renamed. In this case, the **Rename** function is hidden.



Blue button: Activates **Rename** station.

Under the 1st letter of the name you will see a line indicating the current input position.



- ▶ Input position right (also for spaces).
- ◀ Input position left deletes the preceding character.



Enter the letters one after another with the numeric buttons on the remote control. Like using a mobile phone keypad, press a numeric button until the desired character appears. The available letters are printed respectively on the buttons. Different special characters can be selected with button 1.



Green button: Switch upper/lower case letters.



OK to save new name.

Restore stations

Stations which have been deleted from the station list can be restored.

► The restore list is empty if no stations have been deleted yet.



Green button: Activates **Restore stations**.

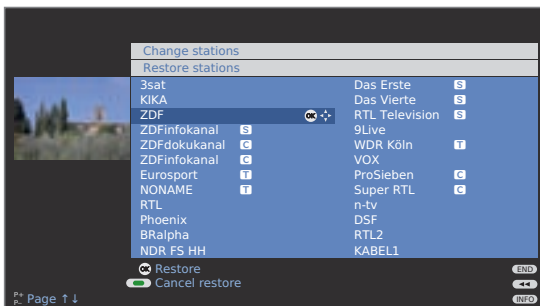

- ▲ ▼ ◀ ▶ Select station,
- OK** station is restored.

The restored station is sorted in according to its signal source at the end of the respective signal block.

Put together – change favourites lists

Each favourites list can contain up to 99 stations. You can put together the favourites lists to suit your requirements (e.g. topic lists). Other persons using this TV set can create their own favourites lists.

The favourites lists also have the advantage that the stations of different signal sources can be stored in the order you wish.

► **Change favourites lists** can also be called via the favourites list (page 17).



Call **TV menu**.



- ▶ Select **Settings**,
- ▼ go to the menu line below.
- ▶ Select **Stations**,
- ▼ go to the menu line below.
- ▶ Select **Select/change favourites**,
- OK** calls list of all stations and last active favourites list.

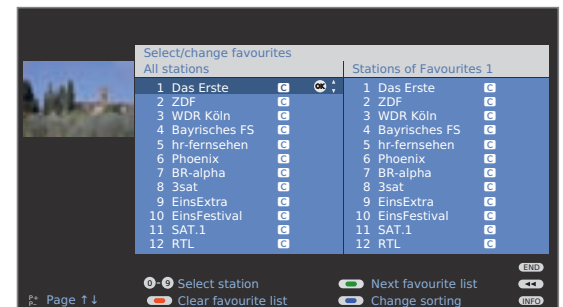

Green button: Select the next favourites list.

Rename favourites list

► Favourites list (right column) must be selected. If not, change the list with ▶.



Blue button: Activates **Rename favourites list**.







Numeric buttons: Enter new name (same procedure as for rename station, see left column).

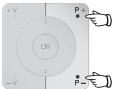

OK to save new name.

Managing stations

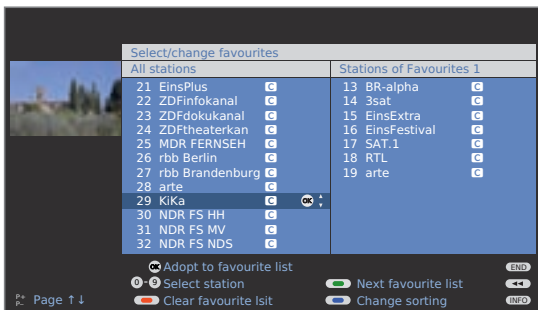

Add station to favourites list

-  ◀ Go to the left column (all stations).
-  **P+/P-** Scroll in the pages of the station list if necessary.
-  ▲ ▼ Mark station or select station with the **numeric buttons** (for alphabetical station sorting enter the initial letter) which is to be transferred as a favourite to the favourites list.
- 
-  **OK** transfers the station to the favourites list. The new station is inserted at the end of the favourites list.







Proceed in the same manner with additional stations.

Delete station from favourites list

- ▣ Favourites list (right column) must be selected. If not, change the list with ▶ .
-  ▲ ▼ mark station to be deleted.
- OK** removes the marked station from the favourites list.
- or:
-  **Red button:** Activates **Clear favourite list**.
-  **OK** confirms clear list.

Move / change order of stations in the favourites list

- ▣ Favourites list (right column) must be selected. If not, change the list with ▶ .
-  ▲ ▼ mark station to be moved.
-  **Yellow button:** Activates **Move station**.
-  ▲ ▼ Select insertion position at which the marked station is to be inserted.
- The insertion position can also be selected with the numeric buttons.
- 
-  **OK** to execute the move.

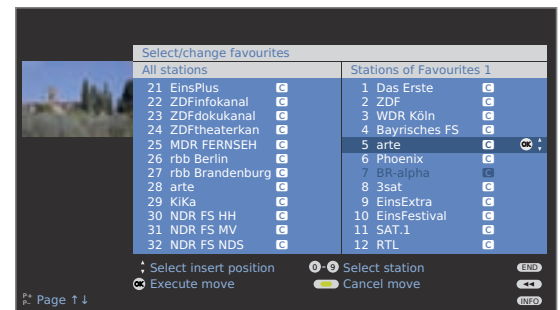

Picture in Picture

Picture in Picture (PIP)

The concurrent display of two different images is referred to as Picture in Picture.

- ⇒ A concurrent representation of two HDTV signals is not possible.
- ⇒ A concurrent representation of two coded stations is not possible.
- ⇒ Picture change and station selection is restricted during recording.

Your TV set differentiates two PIP types:

Split Screen In this case the screen is divided in the middle and the additional PIP image is shown on the right side of the screen. Both images are compressed horizontally and each gets half of the screen.

Small PIP In this case a small PIP image is inserted in the TV picture.





Start and end Picture in Picture mode

 Show/hide PIP.

A green frame indicates that the station selection affects the PIP, A white frame means that the operation affects the main picture.



PIP as freeze picture

⇒ The frame is green, if not, press the **green button**.

    **Red button:** Freeze picture in PIP on / off.

Swap contents of PIP and main picture

⇒ The frame is green, if not, press the **green button**.

    **Yellow button:** Swaps contents.

Select the PIP picture

⇒ The frame is green, if not, press the **green button**.

Select the station as usual.

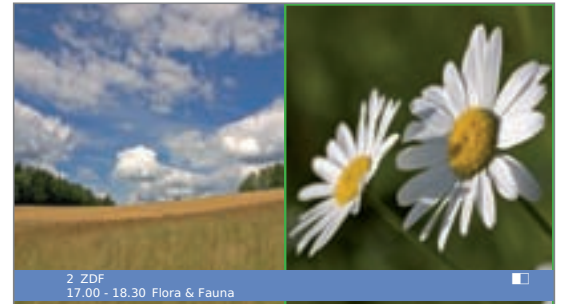

Select the station for the main picture

⇒ The frame is white, if not, press the **green button**.

Select the station as usual.



Scan station in the PIP

⇒ The frame is green, if not, press the **green button**.

    **Blue button:** Start / stop Scan station.

The frame turns blue, the stations now change automatically.

Picture in Picture

Configure Picture in Picture (PIP) mode

In the PIP menu, you can set the PIP type (split screen or small PIP) and the position of the small picture.

Start PIP menu

- ▶ PIP mode started, if not, press **PIP button**.
- ▶ The frame is green, if not, press the **green button**.

MENU

Call the PIP menu.

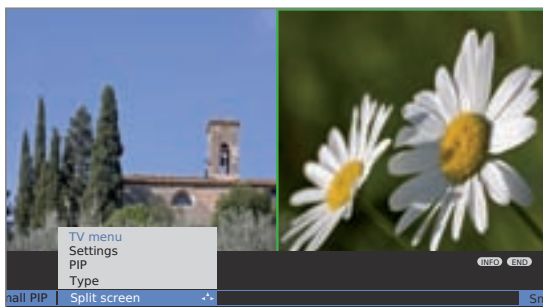

Switch over to small picture

- ▶ PIP menu open.

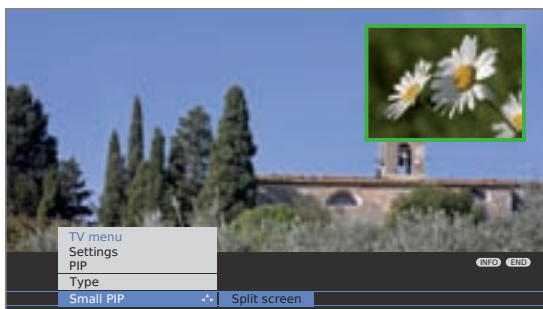

- ◀ ▶ Select **Type**,
 - ▼ go to the menu line below.
- ◀ ▶ Select **Small PIP**.

Change position of the PIP

- ▶ Other than the status line, which may possibly be displayed, no other display is shown on the screen:



- ▲ ▼ ◀ ▶ Move the PIP into a corner of the screen.

Moving the small picture is possible if there is a green, white and blue frame.

The position of the small picture can also be selected under **Position** in the PIP menu.

Switch to Split Screen

- ▶ PIP menu open.

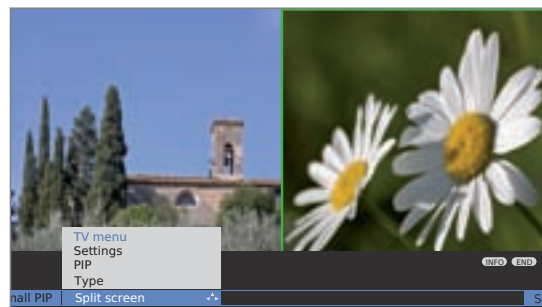

- ◀ ▶ Select **Type**,
 - ▼ go to the menu line below.
- ◀ ▶ Select **Split Screen**.

Electronic Programme Guide

Electronic Programme Guide – EPG

EPG stands for Electronic Programme Guide and provides you with on-screen programme details. With the system, as with a printed programme guide, you can learn about the current programme. In addition programmes can be sorted according to certain topics, memorised, and also recordings can be programmed.

Starting and ending EPG

EPG

Switching EPG on / off



The first time you start EPG a wizard becomes active (not for DVB), and it guides you through the setup. Then execute the data capture (see next page).

The display of the programme guide is divided into two branches. The lower programme list is influenced by the upper default lines.



Blue button: Switches between the upper default lines **date**, ..., **topics** and the lower programme list.

Switching and memorizing with the programme list

- ➡ In the program list first all currently running programmes are listed.
- ➡ You are in the lower programme list, if not, press the **blue button**.



- ▼ ▲ Select station,
- OK** view / memorise.

View The programme is in progress the TV set switches to the marked programme.

Memorise The programme has not started yet and is memorised. A appears in front of the programme. The TV set switches over automatically to the beginning of the programme or, if set in the menu (page 29) on from standby mode.

Adjusting the programme list

➡ Selection is at the top in the defaults, if not, press the **blue button**.

▼ ▲ Select **Date**, **Time**, **Station** or **Topics**.

◀ ▶ Select defaults within the respective line.



Example If you are looking for the next news broadcast, select today's date, for time, select **soon**, for station select **all**, and for topics, select **News**. Then you get a list of all news programmes in the programme list below.

Time entry If the line **Time** is selected, then you can enter the time after which the programmes will be displayed via the numeric buttons of the remote control. Always enter four digits, e.g. 0900 for 9.00 in the morning.

Favourites If a favourites list has been selected in the **Station** line, only the programmes of stations in the favourites list are displayed in the programme list.

Tip Before pressing the **blue button** to leave the upper selection lines, select one of the preceding lines. If you then switch back to the programme list, you can change this menu line with ◀ ▶, without having to leave the programme list. If you have marked **Time**, then you can enter the time, after which the programmes will be displayed, with the numeric buttons of the remote control.

Paging through the programme list



P+/P- paging backwards / forwards.

In the entries for **Date** and **Time**, you will see changes in time as well as in date when paging.

Electronic Programme Guide

Calling additional information about the programmes

⇒ Brief information about many programmes is displayed below the programme list of the broadcasts.



You can call detailed information with the **TEXT button** if this function is offered by the TEXT icon in the lower left.

Programming a recording for a recorder

⇒ Selection is in the lower programme list, if not, press the **blue button**.



▼ ▲ Mark the desired programme.



Red button: Starts recording wizard.

Change or confirm timer data if necessary (see page 46, the direct recording path).

Then a **red dot** will be displayed in front of this programme as an identification.



Red button: Deletes the already programmed recording of the red marked programme from the timer.

If the timer data have been transferred to an external recorder, then the timer must also be deleted there.

Configuring EPG

Start the EPG menu

⇒ EPG mode is started, if not, press the **EPG button**.



Call the **EPG menu**.

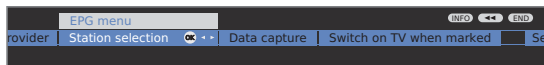

Settings in the EPG menu:

Select provider, Station selection, Data capture, Switch on TV when marked.

Explanations of setting possibilities in the EPG menu:

Select Provider In **analogue TV reception**, there are possibly different providers who broadcast the EPG data for certain station packages. To get another range of stations, you can change the provider with the **Provider selection**. If the provider you are looking for is not in the list, then use the **yellow button** to perform a **Provider search**. The stations offered by the provider will be displayed in a list.

Station selection You can remove certain stations from the programme guide. These stations must be deactivated in the **Station selection**. First, all stations for which programme information can be provided are marked with a . Stations without a are not included in the programme guide.

Marking the stations according to reception ranges:

E analogue stations via antenna/cable, for which the current provider supplies data.

T digital terrestrial stations DVB-T,

C digital cable stations DVB-C,

S digitale satellite stations DVB-S.

Data capture If you want to use EPG for analogue and digital stations, select **on (for DVB + analogue)**. If you want to use EPG and only have DVB reception, select **on (only for DVB)**. If you are not using EPG and therefore do not want to receive any EPG data, select **off**.

After making changes in the EPG menu, or each time the mains switch has been switched off, the EPG data must first be captured. To do this, switch on the device and select (for analogue stations) the station that you have defined as provider, and let the TV set run for about 1 hour with the selected station. Or switch the TV set to standby mode. After 2 minutes the display on the TV lights orange and the EPG data capture begins. When the data capture process has concluded the display will return to red. The data capture process is usually performed between 2:00 am and 5:00 am, when the TV set is in standby mode.

Switch on TV when marked If the TV set is switched on, the TV set will switch over to these stations, if there are any memorised programmes. If the TV set is in standby mode when a memorised programme begins, then you can specify here whether the set should be turned on in this case. If you have set "**yes**" in the menu, the TV set will be switched on. If you are not in at the time, a safety prompt makes sure that the TV switches off automatically after 5 minutes without your acknowledgement.

Teletext

Teletext

Your TV set supports the two operating systems TOP Text and FLOF. Up to 2,000 pages are stored so that you have quick access.

Starting and ending Teletext



Switching Teletext on / off.



Page selection with the coloured buttons

Red button: back to the previously viewed page.

Green button: on to next page.

Yellow button: to next topic.

Blue button: to next range of topics.

The coloured bars (for TOP) or the coloured text (for FLOF) in the second to last line indicate which coloured buttons you can use to page through topic areas and topics.

Teletext page displays



0 AV: Stop self changing pages.



9: Enlarge page (press several times).



PIP button: Show / hide TV picture.



Additional page selection possibilities



1st possibility:
Call **overview page 100**.



2nd possibility:
Directly enter the page number.



3rd possibility:
The page includes 3-digit page numbers.

▼ ▲ mark desired page number.

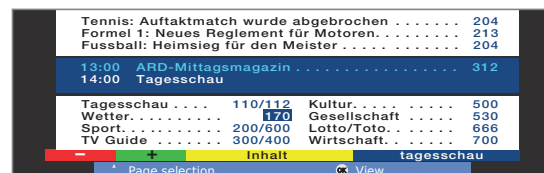

OK to call the page.

4th possibility:

The page consists of several pages. This is shown by the selection possibility in the last line.



◀ ▶ Page through sub-pages.

Call TOP table

The table can only be called for stations with the TOP operating system.



OK Call **TOP table**.

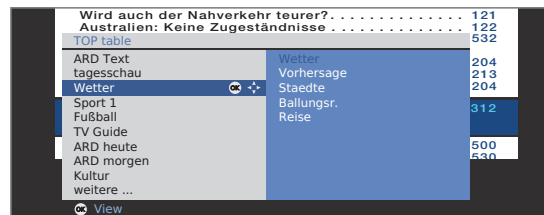

▼ ▲ mark topic area,
◀ ▶ select topic column,
▼ ▲ select topic,
OK to call the page.

Teletext

Programming timer recordings via Teletext

⇒ Teletext is started,
if not, press the **TEXT** button.



Call the programme pages of the current station.
Change preset page numbers, see this page.



Green button: Go to the appropriate page.



▼ ▲ Select the desired programme,
OK to programme the recording.

Change the appropriate recording data in the following
menu **Timer data** if necessary (see also page 46, the direct
recording path).

OK to confirm.

Teletext menu

In the Teletext menu you can, among other things, activate news, reveal
pages and configure the teletext with the **Settings** menu function.

Starting the Teletext menu

⇒ Teletext is started,
if not, press the **TEXT** button.



Call the Teletext menu.



Explanations of the Teletext menu functions:

Newsflash Shows current messages as screen insert, in the form of
subtitles, in current TV mode. Only possible for pages
which also broadcast news.

Reveal Shows concealed information, e.g. for quiz questions or
VPS times in the programme preview pages.

Recording wizard A wizard for **recording** via teletext helps you programme
a connected recorder, see also the left column.

Settings Other Teletext menu functions:

Preview pages Definition of the first Teletext programme preview page if
this deviates from the factory setting (page 301).

Sub-title pages Definition of the Teletext subtitle pages for every station
if this deviates from the factory setting (page 150).

Personal text Definition of up to six Teletext pages which can be called
later from a list in the **Assist+** menu.

Character set Teletext character set can be switched to another lan-
guage.

HiText Improved graphic representation of the Teletext.
(Not offered by all stations.)

Conditional Access Module (CA module)

In order to receive coded digital stations, a Conditional Access Module (CA module) and a Smart Card must be inserted in the CI slot of your TV set (see page 5).

The CA module and the Smart Card are not part of the TV set's scope of delivery. They are usually available from your dealer.

Inserting the Smart Card into the CA module

Push the Smart Card into the CA module as far as it goes so that the side with the gold coloured contact chip is facing the side of the CA module marked with the provider's logo. Note the direction of the arrow printed on the Smart Card.

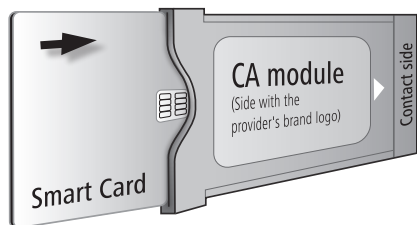

Inserting the CA module in the CI slot

Switch off the TV set's mains switch.

Remove the cover from the rear of the set.

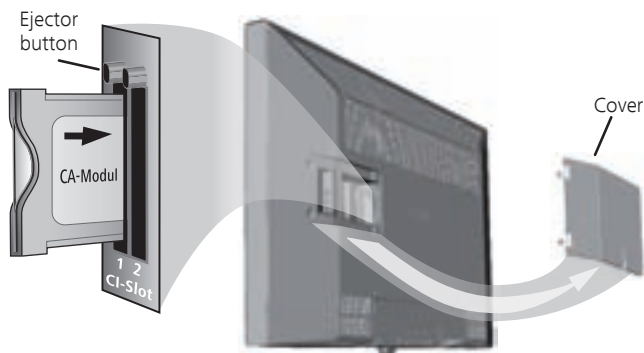

Carefully insert the CA module in CI slot 1 or CI slot 2 with the contact side forward.

If you are standing in front of the TV set (display) then the logo on the CA module must be pointing to the rear. Do not use force. Make sure the module is not twisted in the process.

If the CA module is correctly installed, the ejector button protrudes a little further.

Switch on the TV set

The following dialogue appears:

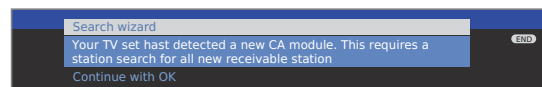

OK start the search wizard.

Check the recommended search routine parameters and then start the search.

Replace the cover.

Calling CA module information

This menu is only available for digital stations.



Call **TV menu**.



▶ Select **Settings**,
▼ go to the menu line below.

▶ Select **Miscellaneous**,
▼ go to the menu line below.

▶ Select **CA module: xxx**
(xxx corresponds to the CA module provider),

OK to call information.

The content of this menu depends on the provider of the CA module.

Removing the CA module

Switch off the TV set's mains switch.

Remove the cover from the rear of the set.

Press in the ejector button on the appropriate module drawer, the module is released.

Remove the module from the set.

Replace the cover.

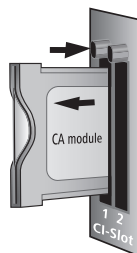

Software update

TV base software and DVB software

To ensure that your TV set is always up to date from time to time Loewe will make updated TV base software and DVB software versions available. These updates are broadcast via satellite (at present only via ASTRA1), or they can be installed on your set via a USB stick. Please contact your dealer for a software update via USB stick.

Automatic search for new software via satellite

The set automatically determines whether a new software version is available per satellite during the night when the EPG data are updated. However the TV set must remain in standby mode for this (do not switch off the set with the mains switch).

If a new software version has been found, the set informs you with an on-screen message the next time it is switched on (see right column – Loading new software).

Manual search for new software via USB /satellite

If it is not automatically displayed that a new software is available when switching on the set, you can also run a manual search. The system first checks whether a software update is available on an inserted USB stick. If not the system will search for an update via satellite.



Call **TV menu**.



- ◀ ▶ Select **Settings**,
▼ go to the menu line below.
- ◀ ▶ Select **Miscellaneous**,
▼ go to the menu line below.
- ◀ ▶ Select **Software update**.
OK calls software update wizard.
The software versions currently loaded in the set are listed.

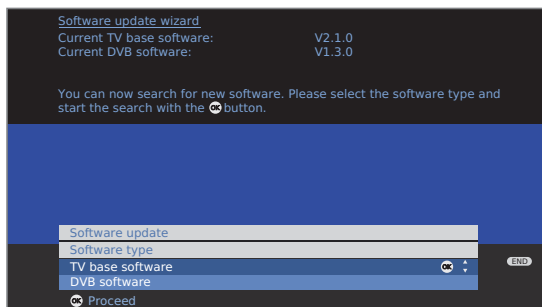

- ▲ ▼ Select software type:
Select **TV base software** or **DVB software**,
OK start search.

If new versions are available then a subsequent screen message will be displayed.

Loading new software

- ➡ New software available via search.
- ➡ If a new TV and a new DVB software is available in the automatic search for new software versions, you can select the software type to be updated.

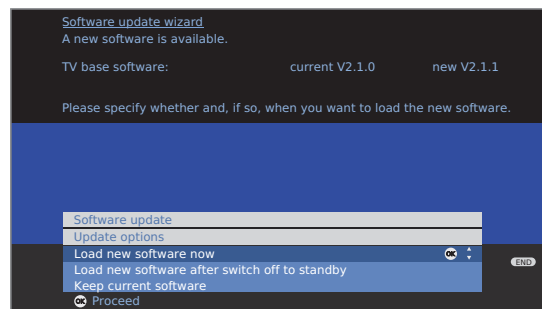

- ▲ ▼ Select update option:
Load new software now
Load new software after switch off to standby (update after switching off)
Keep current software (no update desired)
OK more or exit wizard.
OK start **software update**.

A bar is displayed to inform you about the progress of the load process. During the loading process do not switch off your device via the mains switch! This may last up to 20 minutes. You will be informed when it is finished.

At the end of loading:
Turn off the TV set off with the mains switch and turn it on again. This is not necessary when loading the software with the update option **Load new software after switch off to standby** mode.

If a new software has not been updated via satellite, you will be reminded of this several times when switching on the set.

Radio

Radio mode

You can only receive radio stations via DVB.

If you do not have DVB radio reception then you can play audio from an external device via the TV set using the **audio/AV inputs**.

Radio mode on/off



Radio mode on:

RADIO button on the remote control.

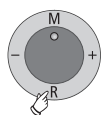

or:

R on the TV set operating ring.



You will see an overview of radio stations.

If data are transmitted by the station, then time and title of the station will be displayed in the station list.

Radio mode off:



TV button on the remote control.

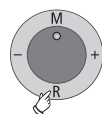

or:

R on the TV set operating ring.

Explanation of the icons after the station name

- T** Digital DVB-T station (terrestrial via antenna)
- C** Digital DVB-C station (via cable)
- S** Digital DVB-S station (via satellite)
- ☐** Coded station

Setting the volume



V+ / V- volume louder / quieter.

Other sound settings are the same as for the volume setting in TV mode (see page 18).

Setting the sound mode



Call **Sound mode**.

Other settings as for TV mode (see page 18).

Switching the screen on/off



Red button: Switch off the screen.

The **LED display** on the TV set changes from green to orange.

Switch on the screen with the remote control:

Red button or **OK** button.

Switch on the screen on the TV set:

Press **R** on the TV set operating ring.

Changing stations when the screen is off



P+ / P- or the **numeric buttons** of the remote control.

or:

+ / - on the TV set operating ring.

Radio menu

In the Radio menu you can set the sound, search for and store radio stations (automatically or manually), change stations and set switch-off/alarm functions.

The settings are made the same way they are made in TV mode.

Call radio menu

➡ Radio mode switched on,
if not, press the **RADIO button**.



Call the **Radio menu**.

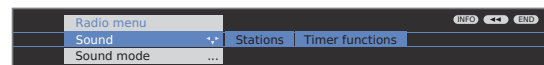

EPG – Electronic Programme Guide (radio)

For the DVB radio stations you can also use an electronic programme guide, if the station that is currently active supplies data.

Starting and ending EPG

➡ Radio mode switched on,
if not, press the **RADIO button**.



Switching EPG on / off

The EPG functions in radio mode are similar to those in TV mode. More information in this regard is available starting on page 28.

Operating additional equipment

Device connection wizard

Connecting additional devices to the TV set

The device connection wizard serves to connect new devices to the TV set or make wiring changes.

➡ New devices should not be connected until they have been registered in the connection wizard.

MENU

Call **TV menu**.



◀ ▶ Select **Connections**,
▼ go to the menu line below.

◀ ▶ Select **New devices/modifications**.
OK calls the wizard.

END

END: It is possible to run the wizard only partially at any time.

You have to confirm changes on a page with **OK**.

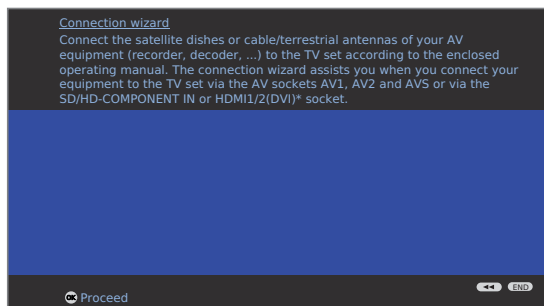

Follow the instructions on the TV set.

The following illustrations provide an overview of the possible options.

Connection diagram

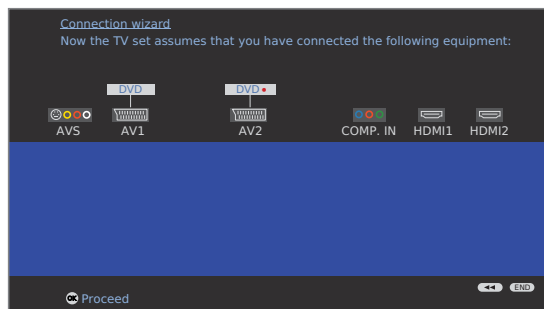

The connection diagram shows the devices that are currently configured. DVD player on AV1 and DVD recorder on AV2 are factory pre-sets.

AV equipment selection

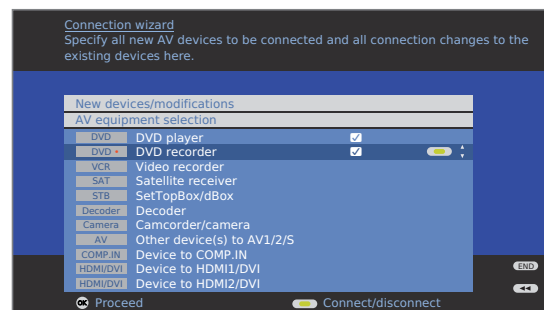

Yellow button: Place a check mark after the devices to be connected.

In the next step, the connection diagram shows how to connect the new or preset devices to the rear of the TV set (in this example the DVD player (**DVD**) to **AV1**, the DVD recorder (**DVD**) to **AV2**).

Signal type

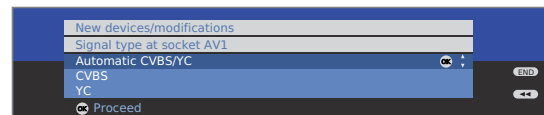

Select the signal type of your set. Leave the setting on automatic if you are not sure.

Connection example of a DVD recorder

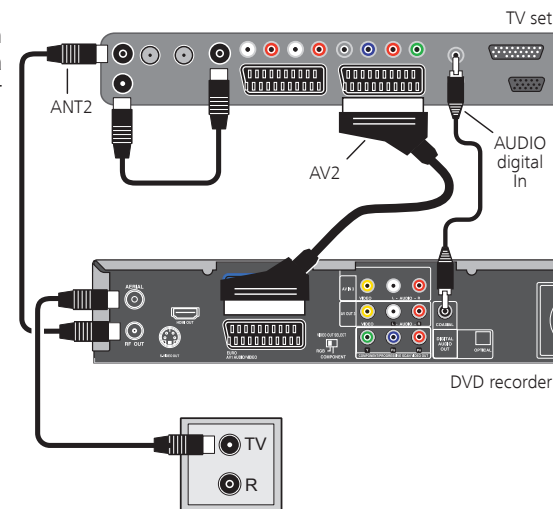

Hint: Use Euro AV cable with angled connectors.

continued on the next page →

Operating additional equipment

Explanations of important settings

Signal type The signal type of the devices that can be connected can vary greatly. If you are not sure, leave the setting for **Signal** on **Automamtic CVBS/YC** (e.g. for DVD Player/Recorder) or **Autom.-VHS/SVHS** (e.g. video recorder), otherwise select the right signal type. See the glossary on page 56 for further information.

Immediate playback If the picture from a connected device is to be displayed immediately on the TV set during playback, select **yes**. A switching voltage is allowed so that you do not have to switch over manually to see the picture of the connected device. (See the operating manual of the connected reproduction device.)

When playing from Digital Link Plus devices, the picture is always displayed immediately, regardless of the setting.

Assign digital audio input Select the AV socket to which the device of which you want to hear the digital sound is connected. Connect the digital output of the external device to the digital input of the TV set (see page 45). If a device with digital audio is not connected then select **no**.

Connection possibilities for a DVD/video recorder

There are two possibilities for viewing the picture of the connected recorder:

1. Use appropriate cables in conjunction with the connections assigned by the connection wizard. This always offers the best quality and the greatest convenience, such as automatic switch over when playing from a connected device.
2. You are using the antenna connection between recorder and TV device. However this reduces the quality.

Connecting antenna to the DVD/video recorder

If you want to receive and record analogue stations, it is useful to loop the recorder into the antenna cable; as shown in the connection example on page 35 bottom right.

If the antenna connection is also used for the playback because the devicers are not connected by EURO-AV cables, you have to search for the recorder station and save it in the TV set.

Proceed as follows (see also the operating manual of the connected recorder):



➡ Insert a DVD/cassette and press play.

Call **AV selection**.

◀ ▶ Select **VIDEO**,
OK to switch over.

If no picture is visible on the TV screen during recorder playback, you have to search for the station or set it manually.

To avoid finding "normal" television stations when searching for stations, unplug the antenna plug on the recorder's antenna input temporarily (the cable for the antenna system).

Manual station search:

➡ **VIDEO** is selected by the **AV selection**.



Call **TV menu**.



◀ ▶ Select **Settings**,
▼ go to the menu line below.

◀ ▶ Select **Stations**,
▼ go to the menu line below.

◀ ▶ Select **Manual adjustment**,
OK to call other settings.

For **Channel** enter "**E30**".



Blue button: Start search.

When you have found the recorder station:



Red button: Overwrite station slot.



Exit **TV menu**.

Re-connect the antenna plug that you temporarily unplugged.

If disturbances should now occur because a TV station is being broadcast on the same channel as the station of the recorder, then you must change the transmission channel on the recorder and scan for the recorder again on the TV set.

Operating additional equipment

Connecting devices to the HDMI (DVI) connections and playback

HDTV HIGH DEFINITION TELEVISION The HDMI connections (High Definition Multimedia Interface) permit digital video and audio transmission via a connection cable from a player, e.g. from the Loewe Centros 2102/2172 HD DVD recorder.

The digital picture and sound data are transmitted without data compression and therefore lose none of their quality. Analogue/digital conversion is no longer necessary in the connected devices, which also would result in quality losses.

Using a DVI/HDMI adapter cable, the digital video signals of a DVI player can also be played via the compatible HDMI connection. The sound must be fed in additionally.

HDMI and DVI both use the same copy protection method HDCP.

Connecting the device



Call **TV menu**.



◀ ▶ Select **Connections**,
▼ go to the menu line below.

◀ ▶ Select **New devices/modifications**.

OK calls the wizard.

OK Go to the **AV equipment selection** menu.

▲ ▼ Select device on **HDMI1/DVI** or **HDMI2/DVI**.



Yellow button: Activate **HDMI1/DVI** or **HDMI2/DVI**.

Connect the device by an HDMI cable (type A, 19 pole) to the **HDMI1/DVI** or **HDMI2/DVI** socket of the TV set.

If a DVI/HDMI adapter cable is used, the appropriate sound can be fed in via the audio input socket **AUDIO IN2** (analogue) or **AUDIO DIGITAL IN** (digital) on the TV set. See also page 45.

Playback from the device



Call **AV selection**.



◀ ▶ Select **HDMI1/DVI** or **HDMI2/DVI** socket,
OK to switch over.

Start playback on the connected device.
The best possible format for the picture will be detected and set automatically.

Connecting devices to the PC IN connection and playback

HDTV HIGH DEFINITION TELEVISION You can connect a PC or a SetTopBox (STB) to the **PC IN** socket and thus use the screen of the TV set as an output device.

► When connecting the TV set to a PC, first set your PC to one of the following screen resolutions:

800 x 600	60 Hz (SVGA)	1024 x 768	60 Hz (XGA)
1280 x 1024	60 Hz (SXGA)	1360 x 768	60 Hz (WXGA)

► When connecting a SetTopBox set the following screen resolutions according to the possibilities of the SetTopBox:

SDTV:	720 x 576i	720 x 480i
	720 x 576p	720 x 480p
HDTV:	1280 x 720p	1920 x 1080i

Connecting the device

Connect the device to the **PC IN** socket of the TV set via the VGA cable. See page 38 for the sound connection.

Registration in the connection wizard is not necessary.

Playback from the device



Call **AV selection**.



◀ ▶ Select **PC IN** socket,
OK to switch over.

Adapting the geometry (only possible with certain signals)

This is where the picture can be properly positioned and the position of the picture (horizontal and vertical) can be moved so that it fills the entire screen.



Call **TV menu**.



◀ ▶ Selecting and adjusting the **Geometry**.

Setting the colour standard (only possible with certain signals)



Call **TV menu**.



◀ ▶ Select **Picture**
▼ Go to the menu line below.
◀ ▶ Select and set **colour standard**:
for PCs: **RGB**,
für STB: **Ycc** (rare: **Ypp** or **RGB**)

If the wrong standard is set then the colours will not be displayed correctly.

Operating additional equipment

Connecting the audio signal from the PC or from the SetTopBox

Analogue audio signal:

Connect the analogue audio signal from the PC or the SetTopBox via stereo cable to the **AUDIO IN2** jack on the TV set.

The sound is played via the speakers connected to the TV set or a speaker system.

Digital audio signal:

► An external digital audio signal can be reproduced via the integrated Dolby Digital Decoder or via an externally connected digital audio amplifier.

Connect the digital audio signal from the PC or the SetTop-Box via a simple cinch cable to the **AUDIO DIGITAL IN** socket on the TV set.

The digital audio input can be assigned to the PC IN socket by the **TV menu** → **Connections** → **Miscellaneous** → **Assign digital audio input**, see page 45.

For an external digital audio amplifier:

► External audio amplifier is already set in the sound components wizard (see page 44).

Feed the digital audio signal of the **AUDIO DIGITAL OUT** socket on the TV set to the external amplifier.

Connecting devices to the Component IN connection and playback



DVD players/recorders with component video connections can also be connected to the **Cb/Pb Cr/Pr Y** sockets (**SD/HD-COMPONENT**) of the TV set instead of to the EURO AV sockets.

The connecting cable with three cinch plugs transmits the picture information in better quality than is transmitted by a EURO AV cable. You need an additional cable for audio transmission.

Connecting the device

Connect the component video outputs of the external device via a triple cinch cable to the **Cb/Pb Cr/Pr Y** sockets on the TV set.

Connect the analogue audio outputs of the external device to the **AUDIO IN1 L/R** sockets on the TV set.

The sound is played over the speakers of the TV set (only with connected TV speakers) or over a speaker system.

Alternatively, connect the digital audio output of the external device to the **AUDIO DIGITAL IN** socket of the TV set.



Call **TV menu**.

◀ ▶ Select **Connections**,
▼ go to the menu line below.

◀ ▶ Select **New devices/modifications**.

OK calls the wizard.

OK Go to the **AV equipment selection** menu.

▲ ▼ Select device at **COMP.IN**.



Yellow button: Activate **COMP. IN**.

Leave the **signal type at socket COMP. IN** in the connection wizard on **Automatic** for the time being.

If necessary change it to: **SDTV**, **HDTV** or **ProScan**. (Additional information is available in the operating manual for the connected device.)

In an analogue audio connection, the sound is automatically played over the speakers of the TV set (only if TV speakers are connected) or over a speaker system. A digital audio signal must be assigned via the **TV menu** → **Connections** → **Miscellaneous** → **Assign digital audio input** to the COMP. IN socket, see page 45.

Playback from the device



Call **AV selection**.



◀ ▶ Select **COMP. IN** socket,
OK to switch over.

Adapting the geometry (only possible with certain signals)

This is where the picture can be properly positioned and the position of the picture (horizontal and vertical) can be moved so that it fills the entire screen.



Call **TV menu**.



◀ ▶ Select and adapt the **Geometry**.

Operating additional equipment

Sound components wizard

The sound components wizard helps you to configure the components used to play the TV sound.

Depending on what you want to use, active speakers, speaker systems and analogue and digital HiFi/AV amplifiers can be configured.

The sound components wizard is set to TV speakers at the factory.

Integrated Dolby Digital Decoder

Your TV set is equipped with an integrated Dolby Digital Decoder. This system has also been introduced to the DVD video range and digital TV stations can also broadcast in digital multi-channel sound.

For playback of 5 audio channels the surround sound is reinforced by the deepest frequencies from the subwoofer channel (SUB), (5.1 reproduction = 5 audio channels and 1 subwoofer). All 5 audio channels are reproduced with the full frequency range from 20- 20,000 hertz and generate the original theatre effect.

The Dolby Digital Decoder also decodes dts, MPEG and the analogue Dolby Pro Logic and Dolby Pro Logic II signals, regardless of whether the audio signal is transmitted by an external device or received by the TV set.

DVDs or CDs with PCM coded audio format are also decoded by the Dolby Digital Decoder. The CD/DVD player must be connected via a coaxial, digital connection to the digital input **AUDIO DIGITAL IN** for this (see page 45).

The audio signals decoded by the Dolby Digital Decoder are output via the **AUDIO LINK** interface. You can connect a speaker system such as the Loewe "Individual Sound" (see page 40) or active speakers (see page 41) to the **AUDIO LINK** interface and configure these with the sound components wizard.

Settings for speaker systems and active speakers which are connected via the **AUDIO LINK** interface to the Dolby Digital Decoder of the TV set:

- Register speaker (system) or active speaker.
- Setting of the lower limit frequency of the speakers.
- Setting of the distances between listener and speakers.
- Level settings for the speakers.
- Setting of the phase position for the subwoofer channel.

All data and selection possibilities which refer to the TV speakers in the course of the sound components wizard are only relevant when TV speakers are connected.

TV speakers

No TV speakers are included in the scope of delivery for the "Individual Compose" TV set. Two speakers (min 4 ohm / min. 20 W sinus) can be connected via the speaker connections (screw terminals) of the TV set.

The Loewe "Stereospeaker I Compose" available as an accessory are ideal for this. These can be fixed directly to the TV set or separately to the wall. When fixing the speakers directly to the TV set, the side speaker connections (exclusively for "Stereospeaker I Compose") behind the trim are used. In the case of separate wall assembly, the speakers are connected to the screw terminals. See installation instructions "Stereospeaker I Compose".

Speakers must never be connected simultaneously to the side connections and to the screw terminals.

Connecting speakers to the screw terminals

To connect the speakers, switch the TV set off at the mains switch and pull out the mains plug.

You have connected and laid out the connecting cables to the speakers.

Remove the rubber band fixed as a transport protection (see figure). Turn the 4 screw terminals anti-clockwise about 2 or 3 turns. This frees the connection openings for the connecting cables of the speakers.

Do not loosen the screw terminals more than necessary. They could fall down and get lost.

Make sure no bare cable ends can get inside the device when connecting. Avoid short-circuits between the individual screw terminals and between the screw terminal and the support plate.

Push the connecting cables (max. 1.5mm²) of the speakers under the respective same coloured screw terminal (red to red, black to black). See also the printed connection designations of the speakers right (Right) and left (Left) and the characters "+" equal red and "-" equal black (see figure).

Make sure that the sheaths of the connecting cables are not clamped accidentally as well.

Tighten the screw terminals clockwise.



Remove transport protection



Attach connection cable

Operating additional equipment

Speaker system Loewe Individual Sound on the Dolby Digital Decoder of the TV set

Setup

The arrangement of speakers and TV set can look like the illustration below:

The front and surround speakers should be installed symmetrically to the TV set and to your sitting position.

You can place the subwoofer anywhere on the floor. We recommend placing it in front asymmetrically next to the TV set.

If a centre speaker is used, it should be placed centrally below the TV set.

For the settings in the sound components wizard enter the distances of the centre speaker, and the front and surround speakers to your sitting position. This guarantees a natural spatial image of the sound.

➡ If you have connected speakers directly to the TV set, you can use these as front or centre speakers depending on the setting in the sound components wizard.

➡ If you have not connected any speakers directly to the TV set, the two front speakers and the centre speaker (Centerspeaker | Compose) are connected to the subwoofer of the Individual sound system.

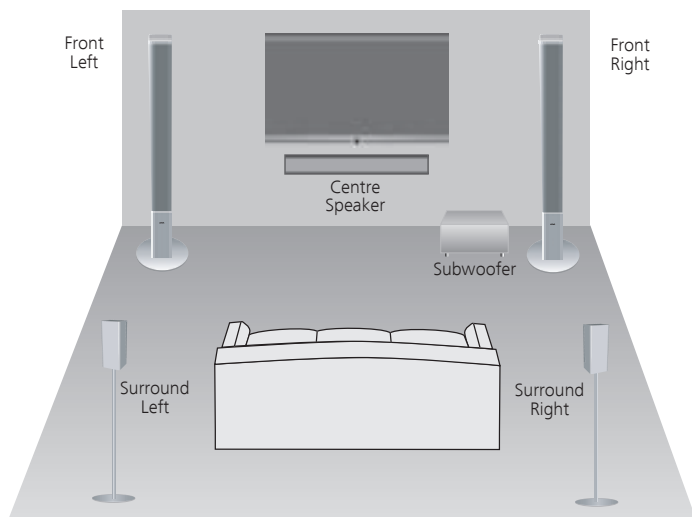

Setup example for Loewe Individual Sound

Connecting

Before connecting any devices ensure that they are switched off or unplug their mains plug.

Subwoofer without **AUDIO LINK** interface:

Plug the adapter cable to the **AUDIO LINK** interface of the TV set. Connect the cinch connections of the adapter cable to the 6-pin cinch connections of the subwoofer. Use the cinch cable which comes with the subwoofer for this.

The cubic plug cable connects the master connection on the subwoofer to the cubic plug of the adapter cable.

The adapter and cubic plug cable are available from your dealer (see Accessories, page 55).

Subwoofer **with AUDIO LINK** interface:

The subwoofer is connected to the TV set via the **AUDIO LINK** interface. Use the **AUDIO LINK** cable which comes with the subwoofer for this (illustrated by the grey dotted line in the figure).

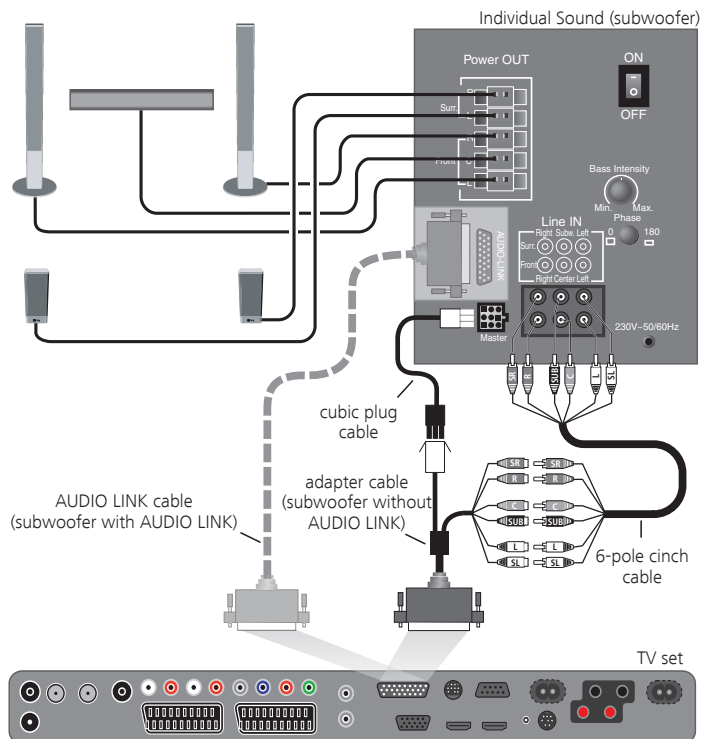

Connecting Loewe Individual Sound (Subwoofer) to the TV set

Operating additional equipment

Connecting other speaker systems or active speakers to the Dolby Digital Decoder

If you want to use another similar speaker system or active speakers, you can connect these to the **AUDIO LINK** interface of the TV set with an adapter cable.

The adapter cable is available from your dealer (see Accessories, page 55).

Connecting

Before connecting any devices ensure that they are switched off or unplug their mains plug.

Plug the adapter cable into the **AUDIO LINK** interface of the TV set. Connect the cinch connections of the adapter cable to the connections of the corresponding active speakers.

The cinch connections of the adapter cable are labelled:

R	for front right
L	for front left
C	for centre
SR	for surround right
SL	for surround left
SUB	for subwoofer

The connections on the adapter cable are preamplifier outputs. Therefore, only active speakers may be connected directly to the adapter cable.

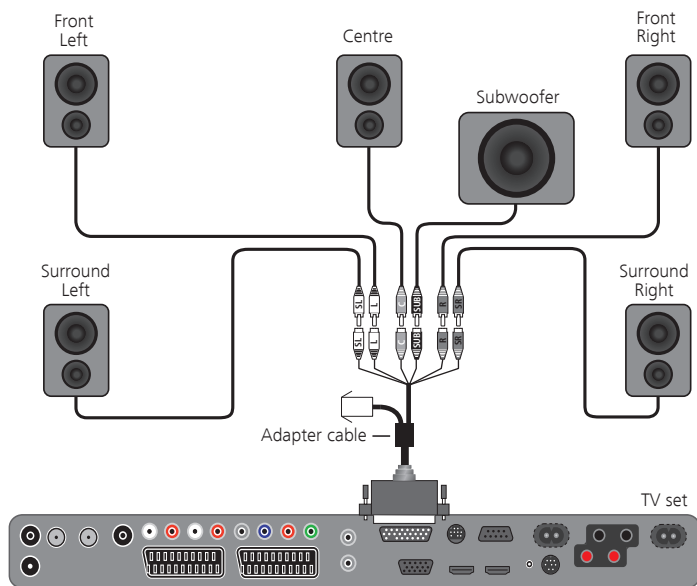

Connection of active speakers to the TV set

Adjusting the speaker system

Calling the sound components wizard

► In normal TV mode, without other displays.



Call **TV menu**.



◀ ▶ Select **Connections**,
▼ go to the menu line below.

◀ ▶ Select **Sound components**,
OK calls the sound components wizard.

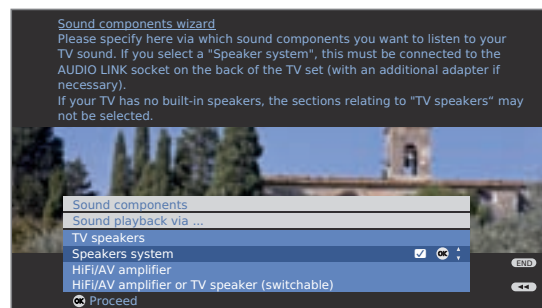

Sound playback via ... speakers system

Enter here that you want to hear the TV sound over a speaker system. If you connect active speakers, please use the setting **Speakers system**.



▼ ▲ Mark **Speakers system**,
OK to continue.

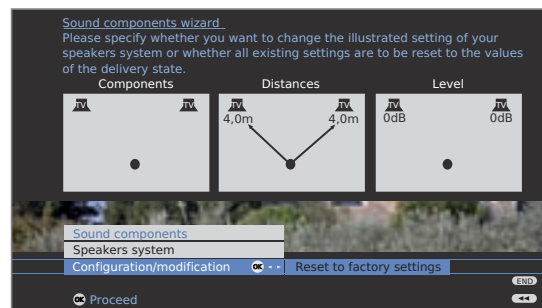

If nothing has been set yet then the factory values will be displayed, otherwise the values last set will be displayed.

continued on the next page →

Operating additional equipment

If you want to set new sound components or change them:



- ◀ ▶ Select **Configuration/modification**, **OK** calls the selection, whether complete, partial or new set-up.

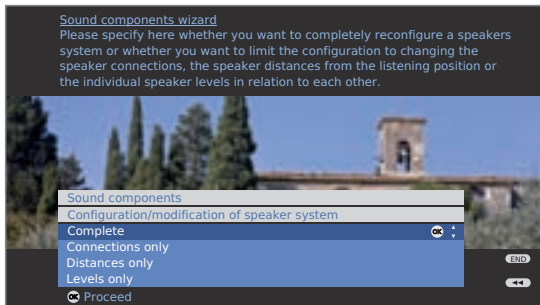

- ▼ ▲ Select **Complete**, **OK** continue to connect and set the **front speakers**.

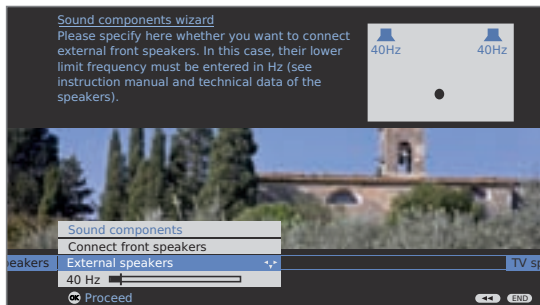

- ◀ ▶ Select **External speakers**,
- ▼ go to the menu line below and
- ◀ ▶ set the **lower limit frequency** of the front speakers in 10 Hz steps.

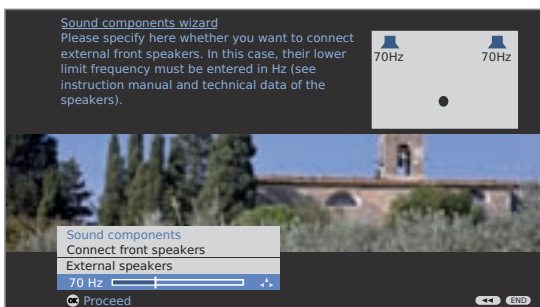

➡ Select the start value of the frequency response of the speakers for the right setting (e.g. 50Hz for the specification "Frequency response 50-20.000Hz"). See the technical data of the speakers for the value.

➡ You can replace the external front speakers by the TV speakers if necessary. In this case, select **TV speakers**. Then transmit the sound of the front speakers.



OK continue to connect and set the **surround speakers**.

- ◀ ▶ Select **yes** for external speakers.
- ➡ If no surround speakers are connected, these can be simulated using the front and centre speakers.
 - ▼ Go to the menu line below and
 - ◀ ▶ set the **lower limit frequency** of the surround speakers in 10 Hz steps.

➡ Select the start value of the frequency response of the speakers for the right setting.



OK continue to connect and set the **centre speaker**.

- ◀ ▶ Select whether the **TV speakers** or an **External speaker** is to reproduce the centre sound or **no** if no centre speaker is connected.
- ➡ If no centre speaker is connected, the front speakers also transmit the centre sound parts additionally.
 - ▼ fo **External speakers** go to the menu line below and
 - ◀ ▶ set the **lower limit frequency** of the centre speaker in 10 Hz steps.

➡ Select the start value of the frequency response of the speakers for the right setting.



OK continue to connect the **Subwoofer**.

- ◀ ▶ **yes** is the selection for subwoofer.
- ➡ If no subwoofer is connected, the front speakers also transmit the sound parts intended for the subwoofer as far as possible additionally.

continued on the next page →

Operating additional equipment



OK continue to set the **Distance from the left front speaker.**

➡ Measure the distances from your sitting position to the front, surround, and centre speakers respectively. The Dolby Digital Decoder calculates the delay times for the speaker signals from these so that they reach the listener simultaneously.

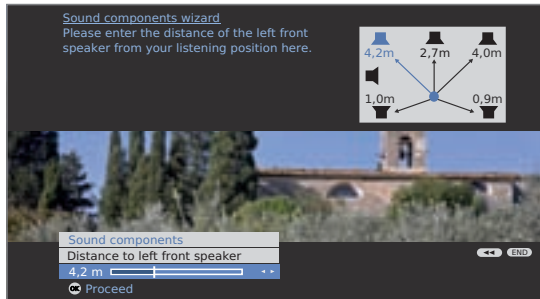

◀ ▶ Set the distance between the left front speaker and your listening position in 10 cm steps.

OK continue respectively to the other speakers and
◀ ▶ adjust the distance.

➡ After setting the distance for the centre speaker ...



OK continue to **Adjust speaker level.**

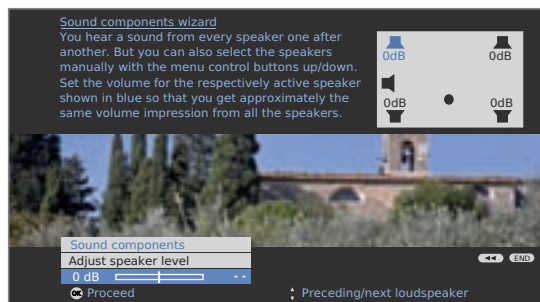

◀ ▶ Adjust the volume for each speaker.

▼ ▲ Select speakers manually.

➡ For balanced audio reproduction all speakers should be set at the same volume level. A noise signal will be reproduced automatically on each speaker in succession. From your sitting position adjust each speaker to the same volume.



OK continue to **Subwoofer phase.**

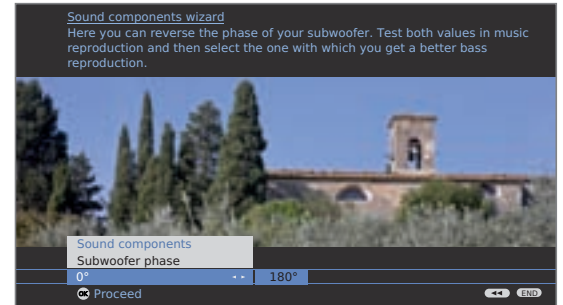

Switch to a station with music with **P+ / P-** or start playback with music on a DVD player.



◀ ▶ Test both values (0° and 180°) and select the one for which the bass reproduction is clearer.

OK to confirm the setting and exit the wizard.

This ends the sound components wizard for connecting and setting up a speakers system.

Operating additional equipment

Connecting audio amplifiers

The sound components wizard permits configuration of different audio amplifiers (stereo amplifiers, surround amplifiers, analogue or digital) with different digital audio formats (Dolby Digital, dts, MPEG, and stereo/PCM). See the operating manual of the audio amplifier for more information.

MENU

Call **TV menu**.



- ◀ ▶ Select **Connections**,
- ▼ go to the menu line below.
- ◀ ▶ Select **Sound components**.
- OK calls the sound components wizard
- ▼ ▲ Mark the **HiFi/AV amplifier**.

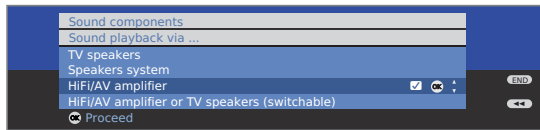

OK to continue.

- ◀ ▶ Select **Digital audio transmission**.

Continue, depending on the amplifier, see right column.

Explanations of the setting possibilities:

HiFi/AV amplifier Select setting if an amplifier is connected and your TV set does not have any TV speakers connected.

HiFi/AV speakers (switchable) Select setting if an amplifier is connected and your TV set amplifier or TV has TV speakers connected. In the sound mode selection the sound reproduction can then be switched back and forth between the amplifier and the TV speakers.

Sound formats Specify sound formats which can be decoded with the digital amplifier (see operating manual of the used amplifier).

Type of amplifier Select either stereo or surround amplifier.

TV loudsp. as centre speaker For every connected surround amplifier, select whether the TV loudspeakers are to be used as centre speaker. If so, establish a connection between the centre output of the amplifier and the centre input of the TV set **AUDIO IN1 C** with a cinch cable.

Attention: Do not use the centre speaker connection of the amplifier, use the centre pre-amp output instead!

Connecting digital audio amplifiers

Continuation of the left column above ...

For digital audio transmission: Select **yes**.

Connect the digital audio output of the TV set **AUDIO DIGITAL OUT** with the digital audio input of the amplifier via a cinch cable:

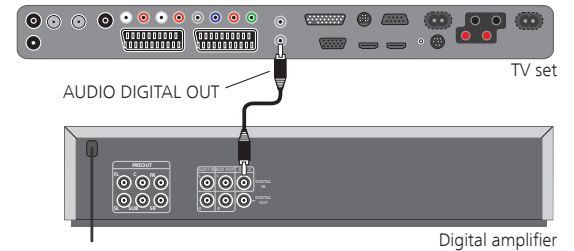

Sound formats, amplifier type and other settings, see explanations of the setting possibilities.

Connecting analogue audio amplifiers

Continuation of the left column above ...

For digital audio transmission: Select **no**.

Connect the analogue audio output of the TV device **AUDIO OUT L/R** via a stereo cinch cable to the analogue audio input of the amplifier:

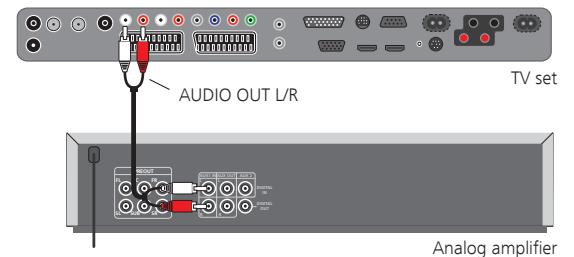

For selecting the amplifier type and making other settings, see explanations of the setting possibilities.

Operating additional equipment

Assignment of the digital audio input

Your TV set can assign an AV input to the digital audio input socket **AUDIO DIGITAL IN**. When switching over to this AV input, the digital audio signal at the **AUDIO DIGITAL IN** input is passed on to the integrated Dolby Digital Decoder and the digital audio output socket **AUDIO DIGITAL OUT**. You will hear the digital sound of the assigned AV input, if available, in place of the analogue sound.

Connecting devices to the digital audio input

You must feed the digital audio signal to the TV set for sound reproduction from an external device, e.g. from the DVD player. Reproduction of the external digital audio signal can be played back via the Dolby Digital Decoder integrated in the TV set or via an externally connected digital audio amplifier.

➡ If an external audio amplifier is used, this must be registered in the sound components wizard (see page 44).

MENU



Call **TV menu**.

- ◀ ▶ Select **Connections**,
 - ▼ go to the menu line below.
- ◀ ▶ Select **Miscellaneous**,
 - ▼ go to the menu line below.
- ◀ ▶ Select **Assign digital audio input**,
 - ▼ go to the menu line below.
- ◀ ▶ Select **AV input**.



To connect a DVD player to the digital audio input of the TV set for example, connect the digital output socket of the DVD player (DIGITAL OUT) via a cinch cable to the **AUDIO DIGITAL IN** socket on the TV set.

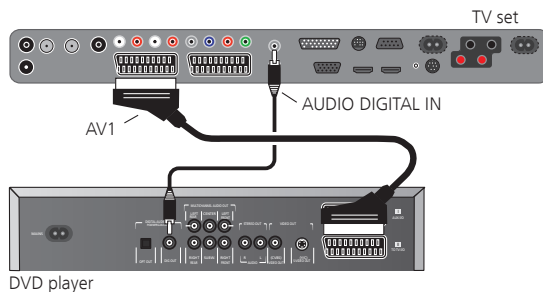

The DVD player is already registered at AV1 in the connection wizard at the factory.

If new devices are connected and registered in the connection wizard, the digital audio input **AUDIO DIGITAL IN** is assigned in the connection wizard (see page 36).

Audio connection in HDMI (DVI) devices

Devices with DVI connection

If an external device with DVI interface is connected via a HDMI/DVI adapter to the **HDMI1/DVI** or **HDMI2/DVI** socket of the TV set, you can connect the digital sound of the external device to the digital audio input socket **AUDIO DIGITAL IN**.

The assignment of the digital audio input to the corresponding HDMI socket of the TV set takes place as described in the column on the left.

If you want to use the analogue sound of the external devices, connect it to the **AUDIO IN2** socket.

Devices with HDMI connection

If external devices with HDMI interface are connected to the **HDMI1/DVI** or **HDMI2/DVI** socket of the TV set, no assignment of the audio input is necessary because the digital transmission of picture and sound takes place via one connection in HDMI.

Operating additional equipment

The direct way to record

You can programme timer recordings via the integrated Digital Recorder or connected recorders on the TV set. The recording wizard is integrated at several places for programming a recording. Further information about recording with the Digital Recorder can be found in a separate operating manual.

Programming a timer recording with the EPG

► You are in EPG mode, if not, press the **EPG** button.



▼ ▲ Mark the desired programme.



Red button: Call **Timer data**.

Change or confirm **Timer data** as necessary.

Programming a timer recording via teletext

► You are in Teletext mode; if not, press the **TEXT** button.



Call the programme pages of the current station.
Change preset page numbers, see this page 31.



Green button: Go to the appropriate page.



▼ ▲ Select desired broadcast,
OK calls **Timer data**.

Change or confirm **Timer data** as necessary.

Enter timer data

Timer data are displayed after selecting the programme you want to record. You can change these before confirming.

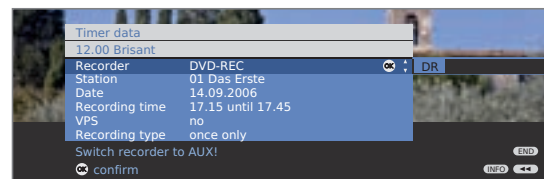

OK confirms **Timer data**,
or change if necessary:

◀ ▶ Select **Recorder**.

▲ ▼ Select **Date**.

Enter the recording date with the **numeric buttons**.

▲ ▼ Select **Recording time**.

Enter the recording time with the **numeric buttons**.

▲ ▼ Select **VPS**.

◀ ▶ Set **yes/no**.

▲ ▼ Select **Recording type**.

◀ ▶ Set **once, Mon-Fri, daily, weekly**.

OK confirm the **Timer data**.



Setting possibilities in the Timer data menu:

- Recorder Selection of the connected/integrated recorder.
- Date Day of recording.
- Recording time Time of recording.
- VPS Use VPS data, yes/no.
(Some stations do not broadcast a VPS signal).
- Recording type once, Mon-Fri, daily or weekly.
Serial can also be selected for timer recordings with the EPG.

► If you use an external recorder without Digital Link Plus, you have to select the recording source in the recorder (e.g. AUX). This is the case when DVB programmes are to be recorded. The TV's receiver is used.

► If you use an external recorder with Digital Link Plus or a comparable system according to protocol 50, this is controlled automatically.

Operating additional equipment

Programming the timer with the timer overview

A timer recording can also be programmed manually.



Call **Timer list**.

You see a list of all previously programmed timers:

Timer list				Mon 31.07/11:28
Mon 14.09.	17:15-17:45	Das Erste	Brisant	
Wed 16.09.	14:00-15:50	ZDF	Biathlon-Weltcup	
Thu 22.09.	20:15-22:25	3sat	wissen spezial	

At the bottom of the screen, there are four buttons: a red button for 'New recording', a green button for 'Change', a yellow button for 'Delete', and a blue button for 'INFO'. There are also 'END' and 'INFO' labels on the right side.



Green button: Change timer recording.

Yellow button: Delete timer recording.

Red button: New timer recording.

Programming the timer manually

➡ The timer overview is open.



Red button: Call the **recording wizard**.

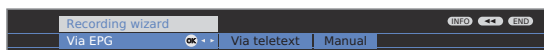

◀ ▶ Select **Manual**,

OK call **Station selection**.

◀ ▶ ▲ ▼ Select station.

OK calls the **Timer data**.

For time data input, see page 46.

After confirming the timer data, the new recording is transferred to the timer overview.

Explanation of the setting possibilities of the recording wizard:

Via EPG Timer programming via EPG (see Programming timer recording via EPG, page 46).

Via Teletext Timer programming via Teletext (see Programming timer recording via Teletext, page 46).

Manual Programming timer manually (see above).

Timer recording with external devices

Recorder with Digital Link Plus

If you use an externally connected recorder with Digital Link Plus or a similar system, the TV set and connected recorder exchange data (e.g. compare station lists TV set/recorder or timer data of analogue stations).

Please consult the operating manual of your recorder to find out if your recorder is Digital Link Plus compatible. In addition use only Euro AV cables for the connection between TV set and recorder.

Analogue stations

The timer data are transmitted automatically from the TV set to the recorder after programming is complete. (For DVD recorders in addition the recording quality SQ or EQ is also transmitted.)

The recording then is controlled by the recorder and the recorder tuner is used for reception of the programme.

The recording data are not saved in the timer overview of the TV set. Consequently if you want to change or delete the timer data then you must do so on the recorder.

Digital stations

If you want to record digital stations with an externally connected recorder, then the DVB tuner is used and the TV device takes over control of the recorder. Then the station on the TV set is locked during the timer recording. It is not possible to switch over to another DVB station.

Recorder without Digital Link Plus

If you cannot programme your externally connected Loewe recorder from the TV set, but it supports Digital Link (Loewe-own system), the receiver of the TV set is always used.

Digital Link must be switched on on the recorder. Read the operating instructions of your Loewe recorder.

In addition use only Euro AV cables for the connection between TV set and recorder.

Analogue and digital stations

You can control the recording from the TV set. The recorder must be set manually to the AV input, to which the TV device is connected. Then the station on the TV set is locked during the timer recording. It is not possible to switch over to another DVB station.

Copy protection

Copy-protected programs will not be output on the EURO AV sockets for legal reasons.

Operating additional equipment

PhotoViewer

You can view photos in the standard JPEG format stored on a USB stick or a memory card in a card reader. You can also collect photos in a slide show.

Connecting

Plug a card reader (with a USB cable) or a USB stick into the USB connection on the TV set (see page 5).

If, due to the selected installation solution of the TV set (e.g. for wall assembly), the USB socket is difficult to access, use a USB extension cable for the USB stick (available from your dealer).

To mount the cover, break out the cable opening in the cover flap.

Starting the PhotoViewer

▶ No photos can be shown which are available in progressive JPEG format.

A memory card or the USB stick should contain data in standard JPEG format with the file extension ".jpg".

PhotoViewer mode starts automatically when a memory card is inserted in the card reader, or when a USB stick is inserted. You see the first page of the photo overview (see right column).

If a memory medium is already connected, start the PhotoViewer as follows:

ASSIST

Call the **Assist+** menu.



◀ ▶ Mark **PhotoViewer**.

OK calls the photo overview.

If several memory cards are available in the card reader, a selection menu **Select memory medium** opens.



◀ ▶ **Select memory medium**.

OK calls the photo overview.

Ending the PhotoViewer

Pull out the memory card or USB stick.

or press:

END

END button.

or:

TV

RADIO

TV or **RADIO** button.

Viewing photos

▶ The photo overview is displayed.

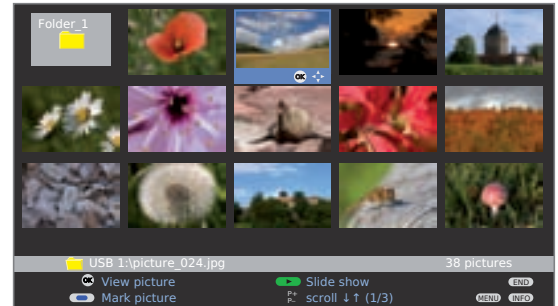

▲ ▼ ◀ ▶ mark a photo, page with **P+/P-** if necessary.

OK display as full picture.



▶▶ or **P+** next photo.



◀◀ or **P-** previous photo.



END: Show/hide photo information.

Extended photo information when Photo info is set to **on** in the PhotoViewer menu (page 49).



Yellow button: Zoom photo. Enlargement factors x2, x4, and x8 are possible. Press the button several times. The 4th press returns you to the original size.

Select photo section in zoom mode with ▲ ▼ ◀ ▶ .

Exit the zoom mode to the photo overview with **OK** or the **STOP** button.



◀ ▶ Rotate picture by 90 degrees to the left/right.

▶ Photos displayed in a slide show can only be rotated in the Pause mode for viewing.



OK or **STOP** button: Back to the Photo Overview.

Operating additional equipment

Open folder

► Folders will only be displayed if they were created on the memory card / USB stick.



▲ ▼ ◀ ▶ mark a folder in the photo overview.
OK open folder.

The photos in this folder are displayed.

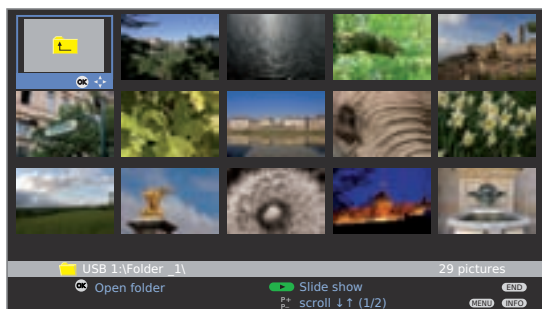

Marking photos for slide show

Mark the photos that you want to display in a slide show.



▲ ▶ ▼ ◀ Navigate to a photo.

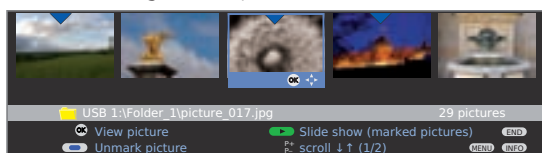

Blue button: marks photo for slide show.

Starting a slide show

► No photos marked: All photos of the folder that was just opened will be displayed.

► Photos marked: Only marked photos will be displayed.



Play button: Start / continue slide show.



OK calls the photo overview.



Pause button: Pause / continue the slide show.



Yellow button: Zoom picture (only in pause mode).



◀ ▶ Rotate picture in 90° increments (only in pause mode).



▶▶ or **P+** next photo.



◀◀ or **P-** previous photo.



STOP button: End slide show.

Calling the PhotoViewer menu

In the PhotoViewer menu you can make picture settings and select the memory medium.

► The photo overview is displayed.



Call the **PhotoViewer menu**.

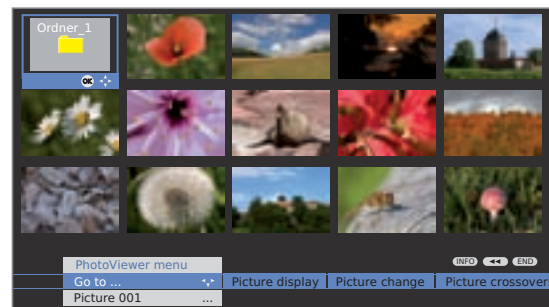

Explanations of the setting possibilities

Go to... Within the folder select a photo directly or go to the beginning or end of the folder.

Picture display With **Optimum size** the photo is reduced or enlarged in size so that the screen is optimally filled. With **Original resolution** each pixel of the photo represents one pixel on the screen. If the photo resolution is higher than that of the screen, then portions of the photo will be cropped.

Picture change Set the display time per photo in a slide show to between 3 and 60 seconds.

The loading time for the photo depends on the size, the number of stored files and the transmission speed of the memory medium. A photo change may therefore take longer than stated.

Picture crossovers There is a choice of four different photo transitions for changing slides. You can also have the photo transitions run in sequence.

Photo info Display additional information about the picture: Recording time and date, resolution and picture size.

Picture settings Set picture adjustment, contrast, colour intensity, colour temperature, brightness, sharpness, DNC.

Select memory medium **Select memory medium** from which the photos are to be reproduced. This menu item is only displayed if at least two memory media are available.

Operating additional equipment

Operating Loewe equipment

Using the remote control for a DVD player

DVD Press the **DVD** button, the display above it will light for approx. 5 seconds.

Using the remote control for a recorder

REC Press the **REC** button, the display above it will light for approx. 5 seconds.

Using the remote control for the TV set

TV Press the **TV** button, the display above it will light for approx. 5 seconds.

Every time the button is pressed, the display of the selected operating mode lights up (TV – REC – DVD – RADIO).

Functions for the Loewe DVD player (Auro 2216 PS, 8116 DT)

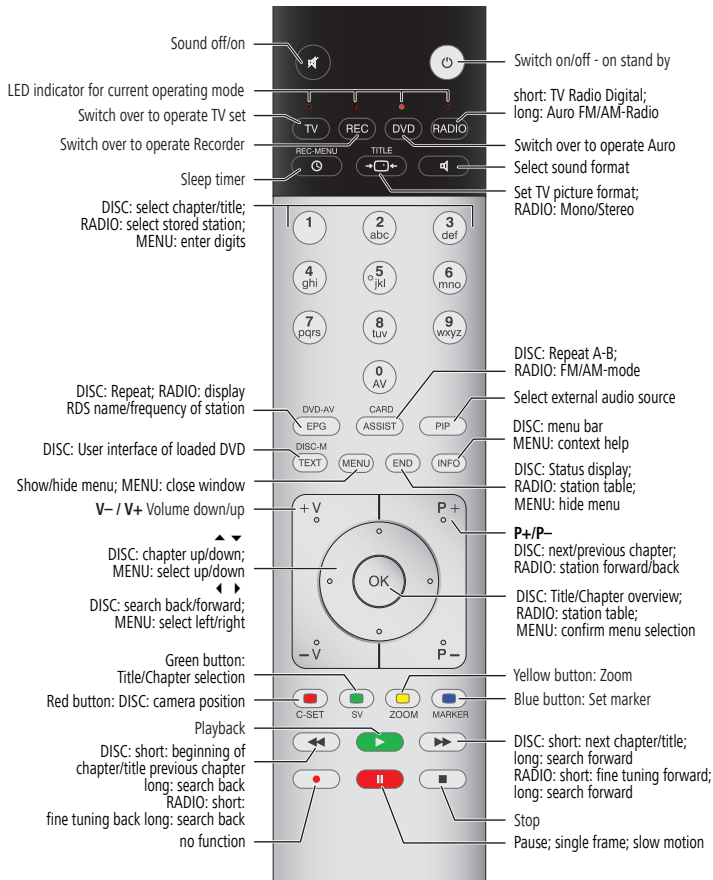

Setting the remote control to other Loewe devices

The specified key combinations must be depressed until one of the LEDs flashes twice (approximately 5s). The devices marked by * are preset in the remote control included with the TV set.

Device	Button combination
Loewe TV (Chassis L2700)	TV + 7 (pqrs) *
Loewe Centros 1102/1172	REC + 1
Loewe Centros 1202/2102 HD/2172 HD	REC + 2 (abc) *
Loewe ViewVision DR+	REC + 3 (def)
Loewe ViewVision 8106 H	REC + 0 AV
Loewe Auro 2216 PS/8116 DT	DVD + 4 (ghi) *
Loewe Xemix 6222 PS	DVD + 5 (jkl) *

Functions for the Loewe DVD recorder (Centros 1202, 2102 HD, ViewVision DR+)

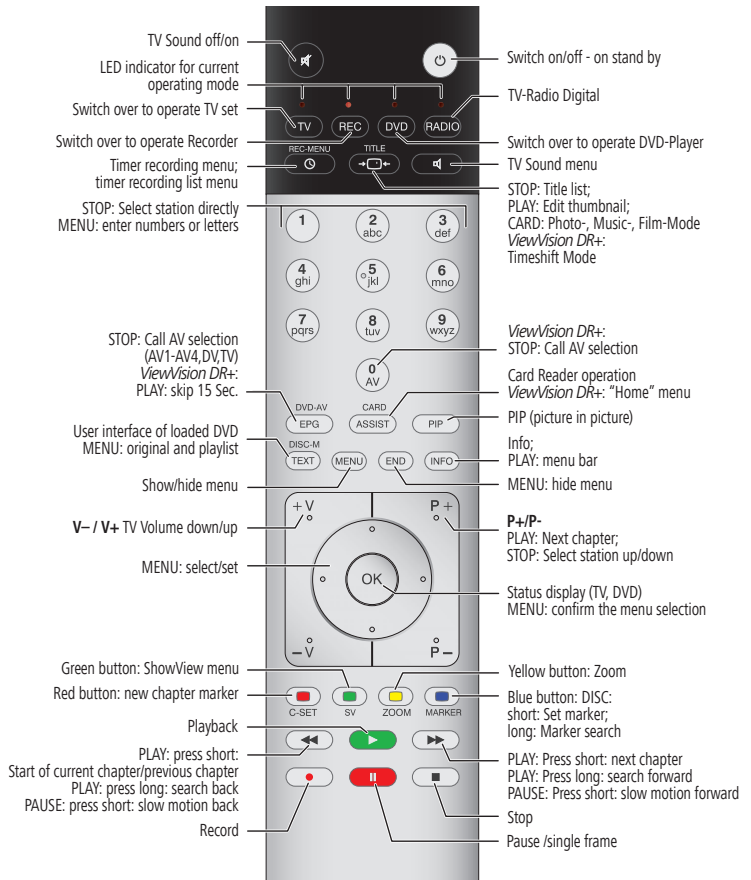

Operating additional equipment

Rotating the TV set

Your TV set has a connection for a rotating stand control. If the set is mounted on a motorised stand, you can use the remote control to adjust it to your seating location accordingly.

- ➡ A motor unit is connected.
- ➡ In normal TV mode, without other displays.
- ◀ ▶ Rotate the TV set.



Do not place any objects in the rotation range of the TV set that could obstruct the rotation or that could be knocked over by the rotation movement.

Setting the range of rotation

You can specify the rotation range of the TV device (maximum +/- 40 degrees) by setting the maximum right and left stop position.



Call **TV menu**.



- ◀ ▶ Select **Settings**,
▼ go to the menu line below.
- ◀ ▶ Select **Miscellaneous**,
▼ go to the menu line below.
- ◀ ▶ Select **Rotate TV**,
▼ go to the menu line below.
- ◀ ▶ Select **Basic adjustment**,
OK calls the basic adjustment.



- ▶ **Basic adjustment (right)**
Turn your TV set as far to the right as the installation position of your set allows. This will be the maximum right rotation position in future.

OK confirms basic adjustment to right.

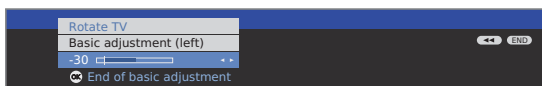

- ◀ ▶ **Basic adjustment (left)**
Turn your TV set as far to the left as the installation position of your set allows. This will be the maximum left rotation position in future.

OK ends the basic adjustment.



Close the menu.

Specifying the switch off position

This is where you specify the position that the TV will take when it is switched off. In order for the TV set to return to the determined switch-off position when switching it off, this must be activated (see below).



Call **TV menu**.



- ◀ ▶ Select **Settings**,
▼ go to the menu line below.
- ◀ ▶ Select **Miscellaneous**,
▼ go to the menu line below.
- ◀ ▶ Select **Rotate TV**,
▼ go to the menu line below.
- ◀ ▶ Select **Set switch-off position**,
OK calls Set switch-off position.



- ◀ ▶ Set desired switch-off position.
The TV set rotates in the process.
- OK** accepts the set position.



Close the menu.

Activating the switch-off position



Call **TV menu**.



- ◀ ▶ Select **Settings**,
▼ go to the menu line below.
- ◀ ▶ Select **Miscellaneous**,
▼ go to the menu line below.
- ◀ ▶ Select **Rotate TV**,
▼ go to the menu line below.
- ◀ ▶ Select **Activate switch-off position**,
▼ go to the menu line below.
- ◀ ▶ Select **yes**.



Close the menu.

If the TV set is switched off with the on/off key on the remote control or with the switch integrated in the display then it will turn to the defined switch-off position. When it is switched back on, it returns to the position last set.

Troubleshooting

Problem	Possible cause	Remedy
All menus are displayed in the wrong language .	The menu language was set incorrectly.	Set the menu language: Press the INFO button in TV mode (Index). Mark the first key word and call it with OK . Then select the language and confirm it with OK .
In the TV menu , Connections cannot be called (displayed in grey).	A timer recording is in progress.	Wait until the timer recording ends or delete the timer recording (page 47).
The control functions of the Loewe Recorder and the Timer are not working or are not working properly	a) The Digital Link function is not activated or not possible in the recorder. b) EURO-AV cable is not connected. c) Recorder is not logged in.	a) Activate Digital Link in the recorder (see operating instructions of the recorder). b) Connect EURO-AV cable (page 35). c) Register recorder (page 35).
General problems when connecting external devices via an AV input .	a) The device is not logged in to the connection wizard or is connected differently from shown in the connection diagram . b) The AV standard is set incorrectly. c) The signal type is set incorrectly.	a) In the connection wizard (TV menu → Connections → New devices/modifications) compare the connection diagram with the actual installation and connect as shown if necessary (page 35). b) Set the correct standard (page 15). c) Set the correct signal type (page 35). If for AV standard or AV signal Automatic is set then this can cause errors to be detected with signals that do not comply with standards. In this case standard and signal must be set according to the information in the operating manual of the external device.
The connection of a decoder does not function or does not function properly.	a) The signal is not decoded because the correct decoder stations have not been selected in the connection wizard . b) In decoder mode the sound is missing because the wrong decoder sound has been assigned in the connection wizard .	a) Follow the instructions in the connection wizard (TV menu → Connections → New devices/modifications) and select the appropriate decoder station (page 35). b) Follow the instructions in the connection wizard and select the right audio source (Decoder, TV oder Autom.) (page 35), see the decoder manual.

Troubleshooting

Problem	Possible cause	Remedy
Digital Link Plus does not work.	a) EURO-AV cable is not fully wired (pin 10 not wired). b) Some recorders can only adopt stations during the initial installation of the TV set.	a) Replace the EURO-AV cable. b) Restore the recorder to the as-delivered state (see recorder's operating manual).
With Teletext various character sets are displayed incorrectly.	The wrong character set has been set in the Teletext menu.	Set the right character set: Teletext menu - Settings - Character set : Select Standard or the appropriate character set.
No sound via the external digital audio amplifier.	a) The external digital audio amplifier does not support the selected sound format (Dolby Digital, dts, MPEG). b) TV set and external digital audio amplifier are not connected with each other.	a) Set PCM stereo on the DVD player in the sound selection. For DVB stations on the TV set switch to stereo in the status display (END) – language/sound selection (Green button) b) Connect Digital-Out from the TV set to a Digital-In input of the external digital audio amplifier and select the appropriate input to this.
The picture of an additional device can be seen but the timer cannot be called.	The device is not registered in the connection wizard or is connected differently from shown in the connection diagram .	In the connection wizard (TV menu → Connections → New devices/modifications) compare the connection diagram with the actual installation and connect as shown if necessary (page 35).
The picture of an additional device can be seen, however the error message no recorder available is output.	The device is not registered in the connection wizard or is connected differently from shown in the connection diagram .	In the connection wizard (TV menu → Connections → New devices/ modifications) compare the connection diagram with the actual installation and connect as shown if necessary (page 35).
Photos on the USB stick are not displayed correctly in the PhotoViewer or a "?" appears.	The photo is not available in a displayable format.	Convert photo file into a standard JPG format on the PC.

Technical data

General data

Type	Individual 46 Compose Full-HD ⁺	Individual 40 Compose Full-HD ⁺
Article number	66439xxx	66437xxx
Device dimensions without base (W x H x D) in cm	114.1 x 67.2 x 11.4	101.4 x 59.7 x 10.3
Weight (approximate) in kg	35,7	27,4
Display	FHD-LCD technology	FHD-LCD technology
Picture diagonal in cm/picture format	117 / 16:9	101 / 16:9
Resolution in pixels	1920 x 1080	1920 x 1080
Dynamic contrast ratio	4,000:1	4,500:1
Static contrast ratio	1,200:1	1,200:1
Viewing angle horizontal and vertical	178°	178°
Power consumption (EN 62087) in operation (watt) in standby (watt)	165 1,8	150 1,8
Ambient temperature (Celsius)	5° – 35°	5° – 35°
Relative humidity (non-condensing)	20 – 80%	20 – 80%
Air pressure	800 – 1114 hPa (0 – 2000 m above sea level)	800 – 1114 hPa (0 – 2000 m above sea level)

Electrical data

Chassis designation: L 2700
 Power supply: 220 V – 240 V/50–60 Hz
 Tuner: VHF/UHF/cable/hyperband
 Range: 45 MHz to 860 MHz
 Station storage locations incl. AV and radio: 4000
 TV standards: B/G, I, L, D/K, M, N
 Colour standard: SECAM, PAL, NTSC, NTSC-V, PAL-V (60 Hz)
 Sound standard Mono/Stereo/2-Ton/Nicam B/G, I, L
 Dolby Digital, Dolby Virtual Speaker, DTS
 Audio nominal power: 2 x 20 watt
 Teletext: TOP/FLOF Level 2.5
 Page memory 2000

Connections

Mains socket: Supply voltage
 EURO-AV 1 Video IN: Y/C (S-VHS/Hi 8)
 CVBS (VHS/8 mm)
 Video OUT: CVBS (VHS/8 mm)
 Y/C (S-VHS/Hi 8)
 Audio IN: L/R
 Audio OUT: L/R
 EURO-AV 2 Video IN: Y/C (S-VHS/Hi 8)
 CVBS (VHS/8 mm)
 RGB
 Video OUT: CVBS (VHS/8 mm)
 Y/C, (only with SVHS Link Plus)
 Audio IN: L/R
 Audio OUT: L/R

Jack 3.5 mm: Headphones 32- 2000 ohm
 Mini-DIN (AVS) Video IN: Y/C (S-VHS/Hi 8)
 Cinch (yellow) Video IN: CVBS (VHS/8 mm)
 Cinch (white/red) Audio IN: L (white) / R (red)
 2x IEC socket 75 Ohm/5 V/80 mA: Antenna/cable/DVB-T/C
 2x F socket 75 Ohm 13/18 V/350 mA: ANT-SAT DVB-S/S2
 2 x screw terminals Speaker Right: + (red) / - (black)
 2 x screw terminals Speaker Left: + (red) / - (black)
 Jack 3.5 mm AUDIO IN2: L/R
 Cinch AUDIO IN max. 2Vrms: Centre
 2 x Cinch AUDIO IN1: L (white) / R (red)
 2 x Cinch AUDIO OUT level adjustable in active speakers: L (white) / R (red)
 Cinch COMPONENT IN: Cb/Pb signal
 Cinch COMPONENT IN: Cr/Pr signal
 Cinch COMPONENT IN: Y signal
 Cinch AUDIO DIGITAL IN (SPDIF): Digital audio
 Cinch AUDIO DIGITAL OUT (SPDIF): Digital audio
 SUB-D AUDIO LINK: Multi-sound
 2 x HDMI Digital Video/Audio IN Type A 19pole Standard 1.2a: .. Digital video and audio
 SUB-D PC IN: PC/STB video signal
 SUB-D RS-232C: serial interface
 Mini-DIN SERVICE: Service/L-Link
 Mini-DIN CONTROL: Rotating stand control
 USB USB 2.0: Data

Accessories

Accessories

Trim:

With your Individual Compose device it is possible to replace the laterally attached trim (panels) to match the ambiance of your home. There are different surface structures or colours that can be selected for your device. Please contact your dealer in this regard.

Wood trim is a natural product. In this case UV light (strong sunlight) can cause slight discoloration.

Stereospeaker I Compose (2 pieces):

Add two stereo speakers to your Individual Compose which can be fixed directly to the TV set or mounted separately on the wall.

Centerspeaker I Compose:

An external centre speaker is recommended for perfect spatial sound. It can be installed on a table stand or mounted on the wall. The Center-speaker I Compose can be combined with the Loewe Individual Sound System.

Loewe Individual Sound:

The Individual Compose can be perfectly supplemented with the Individual Sound speaker system. Numerous speaker combination possibilities with standard speakers, staellite speakers and a subwoofer can be implemented. Here as well it is possible to choose the colours of housing and trim.

Loewe DVD recorder:

The DVD recorders from Loewe are characterised by form and colour, which match Loewe TV sets, adapted user guidance and technology. Combined these devices form a system that offers many advantages.

Cube i Rack:

The Cube i Rack is designed as a supplemental rack that can accommodate two peripheral devices such as DVD player and/or DVD recorder, as well as the subwoofer of the Loewe Individual Sound speaker system. If a subwoofer is not used then the Cube i Rack can accommodate up to four peripheral devices.

Cable:

AUDIO LINK adapter	1.5 m	Loewe order no. 89954.001
AUDIO LINK	1.5 m	Loewe order no. 89952.001
AUDIO LINK	6 m	Loewe order no. 89952.002
AUDIO LINK	10 m	Loewe order no. 89952.003
Cubic plug cable	1.5 m	Loewe order no. 90418.930

Setup possibilities

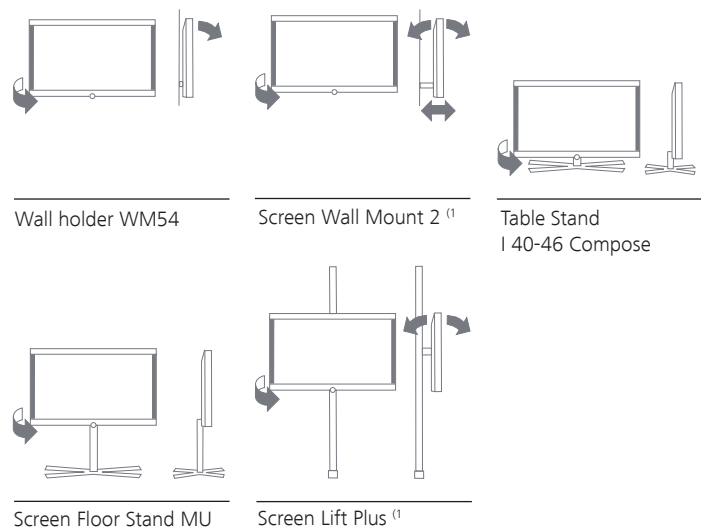

Individual 46 Compose Full-HD+

- Wall holder WM54 (delivery status)
- Screen Wall Mount 2 ⁽¹⁾
- Table Stand I 40-46 Compose
- Screen Floor Stand MU

Individual 40 Compose Full-HD+

- Wall holder WM54 (delivery status)
- Screen Wall Mount 2 ⁽¹⁾
- Table Stand I 40-46 Compose
- Screen Floor Stand MU
- Screen Lift Plus ⁽¹⁾

Glossary

A

Active antenna: An antenna with its own power supply or amplification that can improve reception in areas with poor reception.

AV socket: Socket for audio and video signals.

AV sources: Audio/video source.

AVS: Audio/video sockets on the TV set (cinch and Mini-DIN)

B

Band: Designation for a frequency range.

C

CA module: The **Conditional Access Module** contains the coding system and compares the transmitted code with the one on the **Smart Card**. If they match, the appropriate stations or programmes are decoded.

Cinch cable: Cable for transmitting audio or video.

CI slot: See **Common Interface**.

Common Interface: The Common Interface (CI slot) is a standardised interface. By inserting suitable decoding modules (**CA modules**) and a **Smart Card** coded digital programmes can be used.

Component IN: Connection by which the video signal is transmitted via three separate cinch connections. It is made up of the brightness signal "Y" and the colour difference signals "Pb" and "Pr". **YPbPr** is the original analogue version of the digital **YCbCr** with which, among other things, video data stored on the DVD and transmitted by satellite, cable or antenna in DVB are colour coded.

Conditional Access Module: See **CA module**.

D

Decoder: Analogue, coded TV signals are passed through a decoder and made visible again.

Digital Link: System for controlling recorders (for video and DVD recorders from Loewe) via the Euro AV sockets of the Loewe TV set with concealed setup. Controlling the recorder for timer recordings.

Digital Link Plus: System for controlling recorders according to protocol 50. For analogue stations the station and timer data are transmitted via the EURO-AV socket to the recorder. The timer recording is executed exclusively by the recorder. There is a different designation with different manufacturers.

Dolby Digital: Digital multi-channel audio. The digital standard for high quality home movie systems. The individual channels are broadcast separately in this standard. The three front channels right, left and centre, the two surround channels right and left and the external subwoofer channels are called a 5.1 signal. Another term for Dolby Digital is AC3.

Dolby Pro Logic: Analogue multi-channel audio. Converts a Dolby-coded stereo signal into a surround sound. This usually contains four channels (front left, centre, front right, surround channel). A special subwoofer channel is not generated in this method.

Dolby Pro Logic II: Analog multi-channel audio. Dolby Pro Logic II is a further development of **Dolby Pro Logic**. This method generates a 6-channel spatial sound from a stereo or Pro-Logic signal (front left, centre, front right, surround left, surround right, subwoofer).

Dolby Surround: Analogue multi-channel audio system that brings four audio channels down to two audio tracks with the aid of a matrix coding.

Dolby Virtual Speaker: The Dolby Virtual Speaker technology simulates the surround playback of a real 5.1-channel playback with only two speakers.

DTS: Digital Theater Systems; Digital multi-channel audio.

DVB-C/-S/-T: Digital Video Broadcasting stands for digital television. Technical DVB is the standardised process for transmitting digital content (television, radio, multi-channel audio, room sound, **EPG**, Teletext, and other supplemental services) through digital technology. **C** stands for transmission via cable, **S** for distribution via satellite and **T** for terrestrial or antenna distribution.

DVD: Abbreviation of Digital Video Disk and later Digital Versatile Disk.

DVD preceiver: Combi-device of DVD player and radio without integrated amplifier.

DVI: Digital Visual Interface, is an interface for transmitting digital video and graphic data (without audio).

Dynamic contrast ratio: Here the light intensity of the display is adapted in case of a high black portion in the picture. The so-called backlights are dimmed automatically and the contrast ratio increases temporarily, i.e. dynamically.

E

Electronic Programme Guide: See **EPG**.

EPG: Electronic Programme Guide is the electronic variant of a printed television programme guide. Using the EPG you can watch the TV programme of the TV stations which transfer the appropriate data. The overview of the programmes contains the title, beginning and end and the duration of the programme. In addition also a brief description of respective content of the programme is displayed.

Euro AV socket: Interface for connecting video devices to a TV set. This socket is also referred to as Scart socket.

Glossary

F

FLOF: Full Level One Facilities. Teletext system in which designations and numbers of the jump destinations are transmitted separately for every page on the bottom line. This guides the reader to related topics for example. An information about which pages exist and which pages have sub-pages is not available in FLOF.

H

HDCP: High-bandwidth Digital Content Protection. Coding system provided for the interfaces **DVI** and **HDMI** for protected transmission of audio and video data.

HDMI: High Definition Multimedia Interface is a newly developed interface for full digital transmission of audio and video data.

HDTV: High Definition Television is an umbrella term that covers a number of high resolution television standards.

HD-Ready: A quality seal that is awarded to products which are capable of displaying high-definition television (**HDTV**).

High band and Low band: Transmission ranges for satellites.

J

JPEG: Joint Photographic Experts Group is a committee that has developed a standard method of compression for digital images. This JPEG method (**JPG** for short) named after the committee is a widely used graphic format for photos.

JPG: See **JPEG**.

L

LCD: Liquid Crystal Display.

L-Link: Intelligent system connection between Loewe devices for the automatic exchange of information. Makes the operation of TV and Loewe system components even more convenient.

LNB/LNC: The crucial electronic component of a satellite antenna is referred to as an LNB (Low Noise Block Converter). It is mounted in the focal point of a parabolic antenna. The designation **LNC** (Low Noise Converter) indicates that conversion to lower intermediate frequency takes place. The supplemental block in the LNB refers to the fact that a whole frequency range (a block) is converted in each case.

M

Modulator: Transmitter in the video or DVD recorder so that the devices can receive signals via the tuner of the TV device.

Mono: Single-channel audio.

MPEG: Digital compression process for video.

N

Network ID: NID refers to the so-called programme ID number also known as network ID – a number between 0 and 8191. This specification is necessary in specific cable networks of some countries. Then only DVB signals of this station network are searched for.

NICAM: Audio standard. Is used in Denmark, England, France, Sweden, and Spain.

NTSC: American picture standard.

P

Page Catching: For Teletext, refers to going to and calling a page number.

PAL: European picture standard.

PCM: Pulse Code Modulation for digital audio.

Picture in Picture see **PIP**.

PIP: Picture in Picture; a function which displays two pictures on the screen.

Pixel: Refers to the smallest unit of a digital grid graphic and its representation on a screen with grid control.

Pixel error: A pixel error is a defective pixel, usually on an LCD. Pixel errors may be caused by production faults. They are expressed for example by a constantly lit pixel or a constantly black pixel. Single defective pixels however are excluded from a guarantee.

Progressive JPEG: Progressive **JPEGs** are built up gradually. The picture quality improves continuously during loading.

ProScan/Progressive Scan: Progressive Scan (abbr. PS) or full picture method is a technique in the picture build-up of monitors, TV sets, beamers, and other display devices in which the output device is not sent line interlaced half pictures – unlike in the interlace technique – but real full pictures.

R

RGB: Colour signals red, green and blue.

S

Satellite tuner: Receiver for satellite programmes.

SDTV: Standard Definition TeleVision.

SECAM: French picture standard.

Set Top Box: In the entertainment industry a Set Top Box (STB) is a device that is connected to a different device - usually a television - and thus offers the user additional use possibilities.

Glossary

Signal input groups: The signal sources are divided into different groups depending on the applied signal. All signal input groups with their corresponding signal types and the possible inputs are listed below.

TV analogue:

Signal type: FBAS, YC, RGB-SD (480i/576i), Component-SD (480i/576i)
Input: Tuner analogue, AV1, AV2, AVS, COMP. In

TV digital:

Signal type: DVB-SD, HDMI-SD (480i/576i)
Input: Tuner digital, HDMI1/DVI, HDMI2/DVI

HD analogue:

Signal type: RGB-HD (video mode: e.g. 1920x1080, 1280x720),
Component-HD (video modes: e.g. 1920x1080, 1280x720)
Input: COMP. IN, PC IN

HD digital:

Signal type: DVB-HD, HDMI-HD
Input: Tuner digital, HDMI1/DVI, HDMI2/DVI

PC:

Signal type: RGB
(PC modes: e.g. 800x600, 1024x768, 1280x1024, 1360x768)
Input: PC IN

PhotoViewer:

Input: USB

Signal strength: strength of the received antenna signal.

Signal quality: quality of the incoming antenna signal.

Smart Card: The Smart Card is an electronic chip card issued by the respective programme provider or by the certification-free Pay TV operators. It contains the code which is decoded by the **CA module**.

Static contrast ratio: Describes the difference between the brightest and darkest picture display.

Stereo: Dual-channel audio.

Switching voltage: Video devices specify this voltage to switch the TV device to playback.

Symbol rate: describes the transmission speed for data transmission.

T

Terrestrial: In data transmission a wireless transmission that does not use satellites as intermediate station is referred to as terrestrial.

TFT: Thin-Film-Transistor. One widely distributed application is control of liquid crystal flat screens, for which a signal transistor is used for each pixel. This design of display is also referred to as active matrix, however it is frequently also referred to as TFT display.

TOP: Table of Pages. Teletext system in which the individual pages are divided into topics. The blocks stand for a higher hierarchy level (e.g. News, Sport, Programmes) and the groups for the level below (e.g. Home/Abroad, Football/Tennis). Abbreviations can be assigned to the pages which are displayed in colour on the bottom line and can be selected with the four coloured buttons on the remote control. Information is also transmitted which pages exist and which have sub-pages.

Tuner: Another term for receiver.

V

VGA: PC interface for connecting a monitor.

Virtual Dolby Surround: A technology certified by Dolby. It creates a virtual sound from two speakers. Prerequisite is **Dolby Surround** or **Dolby ProLogic** as a source. The used virtualizer processes all multi-channel signals and gives the impression of additional speakers.

VPS: The Video Programme System (VPS) is a signal that some (not all) television transmitters transmit in the vertical blanking interval of the television signal. The signal is used by video and DVD recorders when recording programmes to react to delays in start time, programme changes and excesses of the planned program time.

Y

Ycc/Ypp: Colour standards for **Set Top Boxes**.

YCbCr: Digital colour model, see **COMPONENT IN**.

YPbPr: Analogue colour model, see **COMPONENT IN**.

 The code number **3001** cancels a secret code and thus the parental lock. Please keep in a safe place.

Index

A

Active speakers 41
Adjusting the picture 19
Adjusting the sound 18
Alarm 15
Assist+ 7, 20
Audio amplifiers 44
Auto format 19
AV audio signal 18
AV selection 17

B

Batteries 10
Brightness 19
Button functions 20

C

CA module 32
Card reader 48
Change favourites lists 24
 Add station 25
 Delete station 25
 Move station 25
 Rename list 24
Change station 23
 Delete station 23
 Move station 23
 Rename station 24
 Restore station 24

CI slot 32

Coloured buttons 20, 21, 30
Component IN 38
Connecting the antenna 10
Connections 5
Connection wizard 35
Contrast 19
Control unit 4
Copy protection 47

D

Data capture 29
Device connection wizard 35
Digital audio input 45
Digital Link 47
Digital Link Plus 46, 47
Display 11
DVB software 33
DVB subtitles 21

DVD button 50

DVI 37

E

EPG 28

F

Factory settings picture/sound 19
Favorites 17
File folder 49
First installation wizard 11
FLOF 30

H

HDMI 37
Headphone volume 18
Help 14
HiFi/AV amplifier 44

I

Index in the TV set 14
Individual Sound 40
Info Display 14
Initialise picture/sound 19

L

Language 11, 14, 52
Language/audio selection 21
Last station 20
LNC/LNB 12
Loudness 18

M

Mains switch 11
Manual station search 23, 36
Manual timer 47
Maximum volume 18
Memorise 28
Memory medium 49
Menu operation 13
Mobile phone keypad 13
Move picture vertically 20
Muting 18

N

New devices/modifications 35
Numeric buttons 13, 14, 16

O

On-screen displays 15
Overview diagram 15

P

Page selection 30
Parental lock 15, 58
PC IN 37
Personal text pages 20, 31
PhotoViewer 48
Picture 19
Picture adjustment 19
Picture format 19, 20
 16:9 20
 4:3 20
 Cinema 20
 PALplus 20
 Panorama 20
 Zoom 20
Picture in Picture 26
PIP 26
Programme info 20

R

RADIO button 11
Radio menu 15, 34
Radio mode 11, 34
REC button 50
Recording 46
Recording wizard 46
Remote control 3, 10, 50
Repeat initial installation 11
Reset picture/sound 19
Rotating the TV set 51

S

Safety 8, 9
Satellite system 12
Scope of delivery 6
Search wizard 22
Secret code 58
Select station 16
Set current time/date 15
Settings 15
Signal type 35, 36
Slide show 49
Small PIP 26, 27

Smart Card 32
Software update 33
Sound 18
Sound components wizard 39
Sound mode 18
Sound off 18
Split screen 26, 27
Standby mode 11
Station list 16
Status display 21
Switching off 11
Switching on 11
Switching voltage 15
Switch on volume 18

T

Teletext 30
Teletext subtitles 20
Time 20
Timer data 46
 Date 46
 Recorder 46
 Recording time 46
 Recording type 46
 VPS 46
Timer functions 15
Timer list 47
Timer recordings 46
TOP 30
TOP table 30
TV base software 33
TV button 10, 50
TV menu 15
TV set equipment 6
TV speakers 10, 39

U

USB stick 33, 48

V

Video source 17
Videotext subtitles 31
Volume 18
Volume adjustment 18
VPS times 31

Service

(A)

Loewe Austria GmbH
Parking 10
1010 Wien, Österreich
Tel.: +43 - 810/0810-24 (zum Ortstarif)
E-Mail loewe@loewe.co.at

(AUS)

International Dynamics
Australasia Pty Ltd.
129 Palmer Street
Richmond 3121, Victoria, Australia
Tel. +61 - 3 - 94 29 08 22
Fax +61 - 3 - 94 29 08 33
Email mail@internationaldynamics.com.au

(B) (NL) (L)

Loewe Opta Benelux NV/SA
Uilenbaan 84
2160 Antwerpen, België
Tel. +32 - 3 - 2 70 99 30
Fax +32 - 3 - 2 71 01 08
Email ccc@loewe.be

(CH)

Telion AG
Rütistrasse 26
8952 Schlieren, Schweiz
Tel. +41 - 44 732 15 11
Fax +41 - 44 732 15 02
Email infocpe@telion.ch

(CY)

HADJIKYRIAKOS & SONS LTD.
Prodomou 121, P.O Box 21587
1511 Nicosia, Cyprus
Tel. +357 - 22 87 21 11
Fax +357 - 22 66 33 91
Email Efthymios@hadjikyriakos.com.cy

(CZ)

Ing. Ivo Tietz
Dolní nám. 9
746 01 Opava, Česko
Tel.: +420 553 624 944
Fax: +420 553 623 147
E-mail tietz@opava.cz

(D)

Loewe Opta GmbH,
Customer Care Center
Industriestraße 11
96317 Kronach, Deutschland
Tel. +49 1801-22256393
Fax +49 9261-99500
Email ccc@loewe.de

(DK)

Kjaerulff 1 A/S
C.F. Tietgens Boulevard 19
5220 Odense SØ, Denmark
Tel. +45 - 66 13 54 80
Fax +45 - 66 13 54 10
Email mail@kjaerulff1.com

(E)

Gaplasa S.A.
Conde de Torroja, 25
28022 Madrid, España
Tel. +34 - 917 48 29 60
Fax +34 - 913 29 16 75
Email loewe@maygap.com

(F)

Loewe Opta France S.A.
13 rue du Dépôt,
Parc del l'Europe, BP 10010
67014 Strasbourg Cédex, France
Tel. +33 - 3 - 88 79 72 50
Fax +33 - 3 - 88 79 72 59
Email loewe.france@wanadoo.fr

(FIN)

Kjaerulff 1 OY
Artturinkatu 2
20200 Turku, Finland
Tel. +358 - 2 284 1600
Fax +358 - 2 284 1601
Email Finland@kjaerulff1.com

(GB)

LinnSight Ltd.
PO Box 8465
KA 7 2YF Prestwick, UK
Tel. +44 - 12 92 - 47 15 57
Fax +44 - 12 92 - 47 15 54
Email helpline@linnsight.co.uk

(GR)

SIBA Engineering S.A.
6, Kifisou Av.,
122 42 Aegaleo, Hellas
Tel. +30 - 210 - 5913793
Fax +30 - 210 - 5317755
Email service@siba.gr

(H)

Basys Magyarorszag KFT
Epitok utja 2-4
2040 Budaörs, Magyar
Tel. +36 - 23 41 56 37 (121)
Fax +36 - 23 41 51 82
Email basys@mail.basys.hu

(I)

Loewe Italiana SRL
Largo del Perlar, 12
37135 Verona (VR), Italia
Tel. +39 - 045 82 51 619
Fax +39 - 045 82 51 622
Email Angelo.Lorenzi@loewe.it

(IL)

PL Trading (pz 2004) Ltd.
27, Aliat Hanoar St.
Givataiim 53401, Israel
Tel. +972 - 3 - 57 27 155
Fax +972 - 3 - 57 27 150
Email info@loewe.co.il

(M)

Mirage Holdings Ltd
Flamingo Complex, Cannon Road
Qormi, Malta
Tel. +356 - 22 - 79 40 00
Fax +356 - 21 - 44 59 83
Email servicing@mirage.com.mt

(MA)

SOMARA S.A.
377, Rue Mustapha El Maani
20000 Casablanca, Morocco
Tel. +212 - 22 22 03 08
Fax +212 - 22 26 00 06
Email somara@wanadoo.ma

(N)

CableCom AS
Gneisveien 12
3221 Sandefjord, Norge
Tel. +47 - 33 48 33 48
Fax +47 - 33 44 60 44
Email soren@cablecom.no

(NZ)

International Dynamics (NZ) Pty Ltd
PO Box 109 317, Newmarket
Auckland, New Zealand
Tel.: +64 9 379 0179
Fax: +64 9 379 0279
E-mail: enquiries@internationaldynamics.co.nz

(P)

Videoacústica
Comercio e Representacoes de
Equipamentos Electronicos S.A.
Estrada Circunvalacao,
Quinta do Paizinho, Arm. 5
2795-632 Carnaxide, Portugal
Tel. +351 - 2 14 24 17 70
Fax +351 - 2 14 18 80 93
Email office@videoacustica.pt

(PL)

DSV TRADING SA
Plac Kaszubski 8
81-350 Gdynia, Polska
Tel. +48 - 58 - 6 61 28 00
Fax +48 - 58 - 6 61 44 70
Email market@dsv.com.pl

(RUS)

Service Center Loewe
ul. Verkhnyaya Maslovka, d. 29
125083 Moscow, Россия
Tel. +7 - 495 612 50 43
Fax +7 - 495 612 47 10
Email service@atc.ru

(S)

Kjaerulff 1 AB
Ridbanegatan 4, Box 9076
21377 Malmö, Sverige
Tel. +46 - 4 06 79 74 00
Fax +46 - 4 06 79 74 01
Email Sweden@kjaerulff1.com

(SK)

BaSys Czech & Slovak s.r.o.
Stará Vajnorská 17/A
831 04 Bratislava, Slovakia
Tel.: + 421 2 49 10 66 18
Fax: + 421 2 49 10 66 33
Email: loewe@basys.sk

(SLO)

Jadran Trgovsko Podjetje
Partizanska cesta 69
6210 Sezana, Slovenija
Tel. +386 - 57 31 04 40
Fax +386 - 57 31 04 42
Email milos.zvanut@jadran.si

(TR)

Enkay Elektronik Servis Müdürlüğü
Alemdag Cad: Site Yolu No.: 10
Ümraniye/ İstanbul, Türkiye
Tel. +90 - 216 634 44 44
Fax +90 - 216 634 39 88
Email mhatipog@enkaygroup.com

(ZA)

Videonix (Pty) Ltd
P.O. Box 31952, Kyalami 1684
Republic of South Africa
Tel. +27 - 1 14 66 47 00
Fax +27 - 1 14 66 42 85
Email mail@loewe.co.za

© by Loewe Opta 060502